

Operating manual

Sound Speed Controller

SFR-1 V1.40

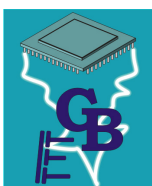
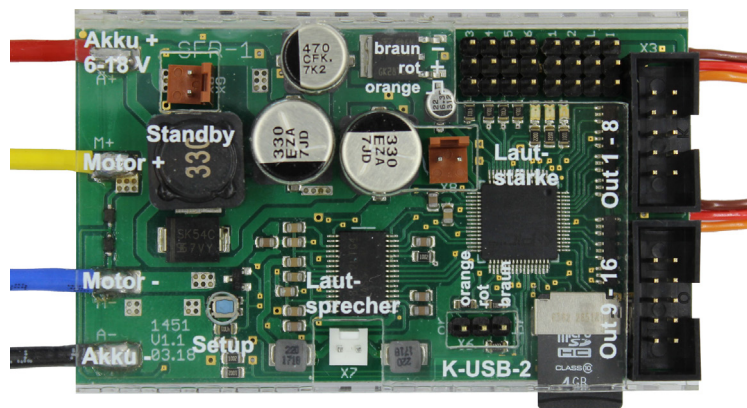

BEIER-Electronic
Winterbacher Str. 52/4, 73614 Schorndorf - Weiler
Telefon 07181/46232, Telefax 07181/45732
eMail: modellbau@beier-electronic.de
Internet: <http://www.beier-electronic.de/modellbau>

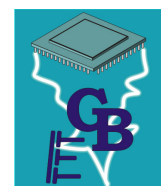

Table of Contents

Table of Contents	2
Introduction.....	4
Safety notes	5
Additional information and help	5
Technical data	6
Pin assignment.....	8
Wiring diagram	9
Installation	10
Connection	10
Setup (teaching function).....	16
Loudspeaker.....	17
Volume control	18
Sounds	20
Engine sound	21
Turning on/off engine sound.....	23
Engine sound 2	24
Functions of SFR-1.....	25
Additional sounds 1 - 30	28
Random sounds	30
WAV-Player.....	30
Functional assignment at proportional channels #1 - #6	32
Stick simulation via keys or switches.....	34
Nautic mode / multiswitch mode.....	35
One-channel multi-function selection (EKMFA).....	36
Sum signals S-BUS, SUMD/SUMD3 and i-BUS.....	36
Digital switches at sum signal SUMD3	37
Switching outputs	37
Output sequences	46
Servo outputs	47
Function sequences	48
Voltage monitoring.....	48
Current monitoring.....	49
LEDs on SFR-1	50
Kraftwerk EasyBus lighting boards	51

PC software „SFR-1 Sound-Teacher“	52
Using software „SFR-1 Sound-Teacher“	54
Saving sounds and configurations on SD card.....	91
Transferring configurations with data cable K-USB-2.....	92
Adjustments of driving sound with the driving sound diagram.....	93
Sound simulation.....	95
Testing functions with help of data cable K-USB-2	95
Diagnosis.....	96
Firmware update.....	99
How to create new sounds	100
How to convert sound files	103
How to edit sounds with the PC.....	104

Introduction

The SFR-1 is a multifunctional module and combines the functions of the sound module [USM-RC-2](#) and the speed controller [UFR-1230](#). It comes with a large light control unit, three servo outputs and a port for the infrared light module [SM-IR-16-2](#) / [LM-IR-16-4](#) or Bluetooth light module [LM-BT-16-4](#), to forward light signals to a trailer.

The SFR-1 is suitable for all types of RC standard transmitter. With the various setting options the SFR-1 can be easily adjusted to nearly all model requirements and driving behaviours. For an easy start we have more than 170 ready to use sound projects and 700 sound files for various types of models. Of course, own recordings can be used, as well.

Sound functions:

For an authentic sound of the model, sounds can be selected for following areas:

- Driving and engine sounds (speed-dependent)
- Additional sounds (e.g. horns, hydraulic and compressed air noises)
- Random sounds (e.g. squeaking, animal and ambient sounds)

Driving functions:

Brushed and bell-armature motors (DC) can be controlled smooth and realistic with the SFR-1. An ideal driving behavior can be achieved through a variety of settings.

The speed controller on the SFR-1 has following characteristics:

- Cruise control functions
- Different brake functions (with hand- and emergency brake)
- Adjustable load regulation
- Adjustable mass inertia
- Steering inertia (with adjustable steering angle limits)
- Adjustment of throttle curve for different driving behaviours

Light functions:

To realize different light effects, the SFR-1 has 16 switching outputs to connect LEDs, lamps and other consumers. Light functions, such as low beam, rear light, brake light, indicator lights, warning lights, flickering lights, etc. can be easily implemented and controlled.

All light functions can be activated or deactivated automatically with sounds and movements.

Servo movements:

With two additional servo outputs, movements can be synchronised to the played sound.

Safety notes

- Please read this operating manual carefully and keep it for future use!
- The integrated circuits on the sound module are sensitive to electrostatic charge. Therefore it is important that you don't touch these components, before discharging yourself (e.g. through a grip onto a grounded device).
- Under certain circumstances unfavourable placement and wiring of the sound module in the model may lead to restriction of transmitter range (mainly with 35/40 MHz transmitter).
- The sound module should only be used with supply voltages that are given in the technical data.
- Always switch off power first before connecting the module!
- The sound module is not suitable for children under 14 years.

Additional information and help

You have problems with your sound module and need additional information?
No worries, we are here to help you!

BEIER-Electronic forum

Check out our [BEIER-Electronic forum](#) on our website. This is the most appropriate place to get quick and competent assistance. In our forum you can ask questions and receive practically proven answers from us and from other forum user. Through an intensive exchange of expertise and experience, all forum users can benefit from the information, presented solutions and ideas. Maybe your question / problem has already been described and you can find immediately the solution (e.g. in the [FAQ](#)).

BEIER-Electronic on facebook

Also visit us on [facebook](#). You can find news and additional information about our products there. Customers of us also founded a [facebook group](#), where you can present your project and get help, just like in our forum.

YouTube tutorials

If you have questions about basic functions of the sound module SFR-1, please watch our YouTube video tutorials with English subtitles. In these videos we explain for example how to connect the sound module and how to program and control different functions.

Technical data

Supply Voltage (U_b):	6 – 18 V DC
Power consumption:	Bias current: approx. 1 mA Standby current (sound, motor and outputs off): approx. 80 mA
Motor current:	Max. 30 A continuous current, 60 A short-term current (1 minute)
BEC voltage:	approx. 5,6 V
BEC current:	max. 3 A continuous current, 5 A short term (10 seconds)
Proportional inputs:	6 inputs Supported protocols: <ul style="list-style-type: none"> • PPM / PCM (1,000 - 2,000 ms) • Sum signal S-Bus (max. 16 channels) • Sum signal i-Bus (max. 16 channels) • Sum signal SUMD/SUMD3 (max. 16 channels) • Nautic / Multiswitch / Multikanal / EMS
Servo outputs:	3 outputs (1,000 - 2,000 ms)
Switching outputs:	16 outputs (nnp – open collector), max. 1,5 A each output, the total current of all outputs is not allowed to exceed 3,0A
Audio amplifier:	20 W (mono)
Recommended loudspeaker:	4 – 8 Ω
Volume setting:	With extra poti (100 kΩ) and/or by the radio
Memory for sound files:	Micro SD card (1 to 32 GB)
May. length of sound:	approx. 180 minutes per 1 GB
Supported file format:	WAV-Format, 8/16 Bit, Mono/Stereo, 22/44 kHz
Sound output:	16 Bit, Mono, 44 kHz
Number of possible sounds:	<ul style="list-style-type: none"> • 5 running steps/gears (internally in up to 255 steps accelerated) • 8 change sounds between the running steps/gears • Turn on noise, turn off noise, starting noise, stopping noise, idling noise, brake noise, reverse warning, curve squeal, flashing lights sound • 30 additional sounds (for example via prop.-channels) • 8 random sounds (random generator) • 30 tracks for WAV-Player
Random sound generator:	Times between 1 to 999 s adjustable

Additional ports:	<ul style="list-style-type: none"> • Programming interface for data cable • Port for infrared diode of light modules SM-IR-16-2 / LM-IR-16-4 or Bluetooth transmitter module LM-BT-S
Protection features:	<ul style="list-style-type: none"> • Short circuit protection at motor output stage • Short circuit protection at switching outputs • Short circuit protection at BEC • Temperature monitoring • Battery voltage monitoring • Protection while switching on power supply • Failsafe for proportional inputs
Cables for connection:	<ul style="list-style-type: none"> • For battery: 2 x 1,5 mm², length approx. 15 cm (with Deans T male connector) • For Motor: 2 x 1,5 mm², length approx. 15 cm • For receiver: servo patch 3 x 0,14 mm², length approx. 30 cm
Permissible ambient temperature:	0 – 60° C
Permissible relative air humidity:	Max. 85 %
Dimensions:	81 x 49 x 23 mm (with SD card: 81 x 52 x 23 mm)
Weight:	86 g

Pin assignment

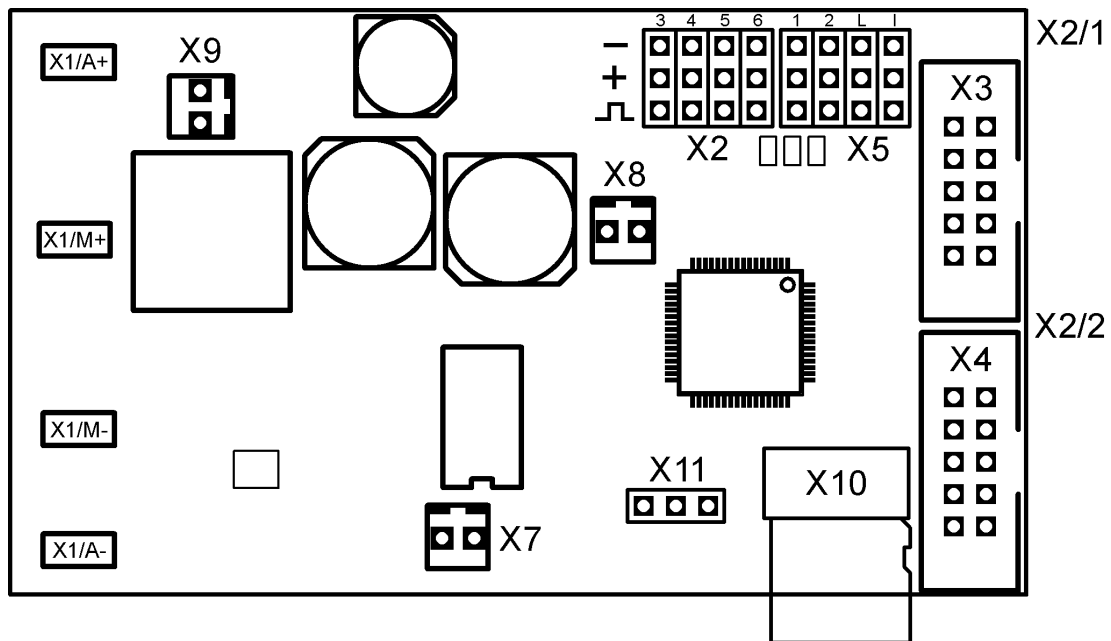

Connections at SFR-1:

X1/A+	Battery + / Akku + (6 – 18 V)
X1/A-	Battery - / Akku -
X1/M+	Motor +
X1/M-	Motor -
X2/1	Proportional input #1 (throttle channel)
X2/2	Proportional input #2 (steering channel)
X2/3	Proportional input #3
X2/4	Proportional input #4
X2/5	Proportional input #5
X2/6	Proportional input #6 / Sum signal input / Bluetooth module BTC-1
X3	Switching outputs 1 - 8
X4	Switching outputs 9 - 16
X5/1	Servo 1 / Kraftwerk EasyBus
X5/2	Servo 2
X5/L	Steering servo / I-servo
X5/I	Connection for infrared diode or Bluetooth transmitter for light modules
X7	Loudspeaker
X8	Volume control with poti
X9	Optional switch (Power off / standby)
X10	Micro SD card
X11	Port for data cable K-USB-2

Wiring diagram

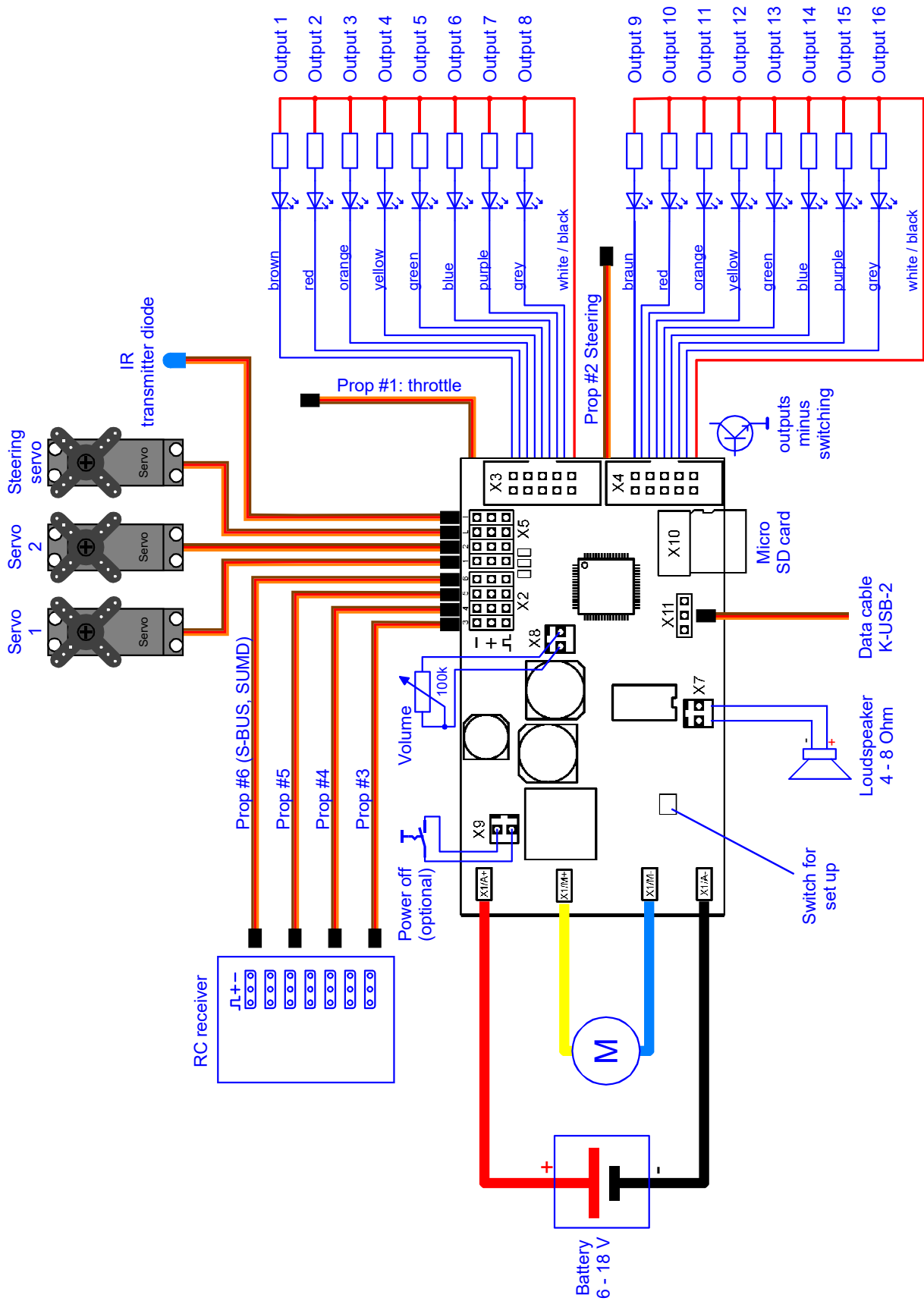

Installation

For a safe installation of the sound speed controller, we recommend to use Velcro tape on the SFR-1 cover.

Pay attention not to connect components and conductor tracks with any metal parts! This may cause a short circuit, which destroys the SFR-1!

Connection

Always switch off power before connecting the module!

Connection of supply voltage (battery)

The SFR-1 is suitable for 6 – 18 V DC. Choose a suitable battery for your motor.

In order to connect the power supply the red cable is connected to the positive pole of the battery and the black cable to the negative pole of the battery.

For an easy connection, the speed controller is delivered with a Deans T-male connector, which allows easy plugging and prevents accidental reverse polarity.

If the supply voltage is connected, the green LED on the module lights up.

Pay attention to a correct connection of the supply voltage poles! A wrong connection destroys the speed controller immediately!!!

Connection of motor

The SFR-1 is suitable for all DC brushed and bell armature motors with a maximum continuous current of up to 30 A. Up to one minute, a current peak of 60 A is possible. With the following formula you can easily calculate the required values:
Current (A) = Power (W) / Voltage (V).

The yellow cable is used to connect the positive pole of a motor. The blue cable is connected to the negative pole of the motor.

In case the driving direction is wrong (forward and backward are opposite), you can change the connection cables of the motor or you can invert the driving direction in your Sound-Teacher, see page 60.

If you want to disconnect the supply voltage of the SFR-1 from the battery, always disconnect the positive lead of the battery first (or plus and minus at the same time)! Never disconnect the negative lead first (or only)!

In case of poor or no interference suppression motors can be strong sources of interference, which may interfere with the electronics of the SFR-1, especially the sound output (whistling, buzzing in the speaker. Therefore motors should be suppressed! With a 2.4 Ghz transmission and a current motor, which is usually already suppressed, disturbances are rare.

If you have problems with interferences, the motor can be additionally suppressed with three capacitors, as shown in the figure. The C1 capacitors are connected to the motor housing.

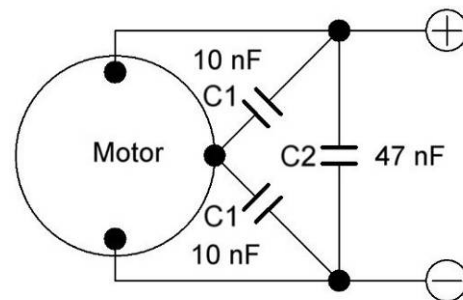

Connection of proportional inputs

To proportional inputs X2/1 - X2/6 up to 6 proportional channels can be connected to the receiver. To proportional channels #1 and #2 there are already servo cables soldered. For connecting the pin headers servo patch cables (15 and 30 cm) can be ordered in our online shop.

Throttle channel Prop #1 (X2/1) must be connected to the receiver in order to control the pace of the speed controller.

Steering channel Prop # (X2/2) needs to be connected in case one of the following functions should be used:

- Activation of indicator lights by steering
- Automatic flashing of indicator lights while steering
- Steering inertia and steering angle limitation
- Forwarding of the steering signal to the trailer / semitrailer via IR signal or Bluetooth

When using a sum signal (e.g. SUMD, S-Bus or i-Bus), the signals for throttle and steering can also be transmitted to the SFR-1 via the sum signal. Connections #1 (X2/1) and Prop #2 (X2/2) can also remain free in this case.

The servo patch cables must be connected to the SFR-1 with the orange cable pointing to the center of the board (down) and the brown cable to the edge (up).

Functions of the proportional channels:

Prop	Function
#1	Throttle channel / speed information
#2	Steering
#3	Free function assignment / EKMFA / Nautic 1 / Control pad
#4	Free function assignment / Nautic 2 / Control pad
#5	Free function assignment
#6	Free function assignment / Sum signals S-BUS, i-BUS or SUMD / Bluetooth module BTC-1
#7 - #16	Free assignment of functions (can only be used with a sum signal)

The channel numbers of the SFR-1 have nothing to do with the channel numbers of your receiver. You do not have to connect channel #1 of the receiver with channel #1 of the SFR-1. If the joystick (to accelerate your model) is for example at channel #3 of the receiver, you have to connect channel #3 of the receiver with channel #1 of the SFR-1.

BEC – receiver supply voltage

The SFR-1 has its own BEC supply voltage of 5,6 V an additional receiver battery is not required. The maximum continuous BEC current is 3 A. A current of 5 A is possible for a maximum of 10 seconds.

In case the BEC voltage of the SFR-1 should not be used, the red cable from all servo cables from proportional channels #1 - #6 must be disconnected!

Connection of loudspeaker

The loudspeaker is connected to X7 at the SFR-1.

The red cable is connected to the positive and the black to the negative pole of the loudspeaker.

The supplied loudspeaker connection cables should not be extended to prevent interference of the receiver (especially with FM systems)! The loudspeaker cables should be installed with a maximum of distance to receiver and antenna.

Connection of switching-outputs

The outputs 1 -16 of the module are located at the pin connectors X3 and X4.

The supplied [ribbon cable](#) can be used to connect the outputs. For easier connection, the terminals [AKL-8](#) and [AKL-8-W](#) can be ordered from our shop.

Of course other cables/plugs with a cross section of 0,14 mm² - 0,5 mm² can be connected as well.

The SFR-1 is always switching the negative pole to each output and thus to the connected load. The negative pole is always connected to the load (see wiring diagram).

The common positive pole for outputs 1 – 8 and 9 -16 are the black and white cables. It is also possible to connect the load directly to the positive pole of the battery.

Ribbon cable assignment:

Output	Ribbon cable (X3)
1	Brown
2	Red
3	Orange
4	Yellow
5	Green
6	Blue
7	Lila
8	Grey
+	White
+	Black

Output	Ribbon cable (X4)
1	Brown
2	Red
3	Orange
4	Yellow
5	Green
6	Blue
7	Lila
8	Grey
+	White
+	Black

The switched voltage at the outputs (with 100% intensity) is always as high, as the supply voltage of the SFR-1. For example if the module is supplied with 12V, only lamps with 12V should be connected.

If you want to connect LEDs, series resistors are always required. Furthermore, attention must be paid to the correct polarity of the LED. The series resistors for the LED's are depended on the supply voltage, the LED-color and the LED-current.

The table below shows the resistance values required for standard LEDs (approx. 15 mA current):

Supply voltage	Series resistors
6 V	270 Ohm
7,2 V	330 Ohm
8,4 V	470 Ohm
9,6 V	510 Ohm
12 V	680 Ohm

In the internet you will find various pages to calculate the necessary resistor value.

If multiple LEDs are connected to one output (e.g. front and rear direction indicators), it is always better to use separate resistors than to connect the LEDs in series.

Connection of data cable K-USB-2 (X6/2)

The data cable K-USB-2 is connected to X11. The brown cable points to the SD card.

The speed controller is not powered by the data cable. For using the data cable, the SFR-1 must be supplied with power via the battery as normal.

Connection of an optional "Standby switch"

An optional switch can be connected to slot X9 to switch the complete module into a standby mode. If the switch is closed at X9, the BEC voltage is switched off and the processor of the SFR-1 goes to standby.

The current consumption of the module drops to a current of about 1 mA. This allows to stay on standby for several hours without noticeably draining the battery. However, if the model is not used for several days, the battery should be disconnected completely.

If no switch is connected to X9 or the switch is not closed, the SFR-1 will operate normally.

At the standby switch there is only a small spreader current of a few μA and not the complete current of the module. Consequently, a much smaller "standby switch" can be installed.

General remarks for wiring

Always use cables with a core diameter of at least 1,5 mm² for connecting the power supply and the motor. For all other connections, such as lights you can use smaller cables such as 0.25 mm².

Unfortunately motors are often strong interference sources, which could disturb other electronic modules in your model. Therefore all motors should be absolutely interference-suppressed!

It is important to pay attention to „clean" wire routing. Always use short wires and avoid any unnecessary loops. The supply voltage wires of the speed controller should be connected to the driving-battery as direct as possible.

Setup (teaching function)

With the teaching function important parameters can be synchronised between the radio and the SFR-1.

During the setup, the neutral positions of all connected channels are read in and adapted to the encoder positions. For this it is absolutely necessary that all stick or switch positions are neutral at the radio.

The SFR-1 is delivered with following standard setting: neutral position (1,5 ms), minimal position (1,0 ms) and maximal position (2,0 ms).

We recommend to „teach“ the SFR-1 with the radio at least once. The motor is not used during the setup.

The setup can be started with the blue setup button on the SFR-1 board, with the data cable K-USB-2 and with the function „start setup“ (proportional channel or nautic/multiswitch).

1. Connect throttle channel, steering channel and all other proportional channels you want to use to your receiver.
2. All channels must be in neutral position. Switch on transmitter first and then the SFR-1.
3. Activate the setup, with the blue „Setup“ button on the SFR-1 board, until the green LED flashes fast. The blue LED flashes once.
4. With correct signals at the throttle channel (X2/1), all neutral positions are saved. If the red LED is flashing, the SFR-1 can not detect a correct signal at X2/1. Please check all connections and start the complete module again.
5. Press the throttle stick to full throttle for one or two seconds and return to neutral position.
6. Wait until the blue LED flashes two times and lights permanently afterwards.
7. Within 10 seconds press the throttle stick down and give full throttle backwards and then return to neutral position. The blue LED flashes three times. The green LED lights permanently afterwards.
8. The setup is completed.

Loudspeaker

You can connect every loudspeaker to the SFR-1, which has an impedance of at least 4 Ω and is designed for the respective maximal power. We recommend using full range loudspeakers with 4 or 8 Ω . Higher impedances are also possible, but the volume decreases with higher impedances.

The maximum power and thus the volume of the sound module, is also heavily dependent on the height of the supply voltage.

To reach a perfect level of volume and sound quality, you have to install the loudspeaker in a suitable resonant body (loudspeaker box). A loudspeaker, which lies only on the table, never reaches an optimum sound quality.

At every amplifier heat arises through power dissipation. This heat must be dissipated by a cooling element into the air. Always pay attention to a good air circulation to prevent overheating. Especially at higher voltages (e.g. above 9,6V) it might be necessary to use active cooling of the SFR-1 with a little fan.

If the output power is still not enough for your application, it is possible to use a speaker to RCA line level converter (high/low) mit galvanic separation (used in car radios) and a small capacitor (10nF) at the input, in order to connect an additional amplifier.

Volume control

A volume control is possible by an external potentiometer or by different functions with the radio.

The external potentiometer (100 kΩ) is connected to X8 (see wiring diagram, page 9).

If no potentiometer is connected, always the maximum volume is used, which is configured in the Sound-Teacher (10 – 100 %) at Configuration → General → „Overall volume (%)”.

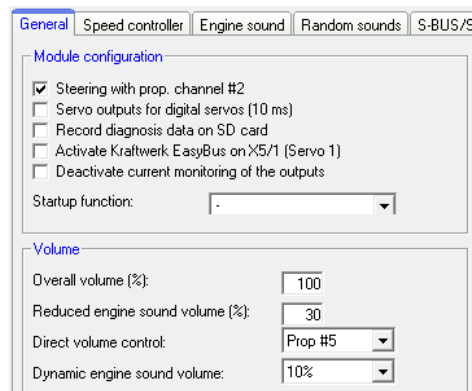

The volume can be steplessly controlled via one proportional channel and the "Direct volume control" setting. A slide switch or knob on the remote control is recommended with this function. The proportional channel can in this case not be used to trigger other functions.

The volume can also be controlled by the remote control. The functions "Volume +" and "Volume -", must be configured in the Sound-Teacher e.g. to a proportional channel or to a nautic/multiswitch.

The volume of each sound can be changed individually as well. You will find the setting in your Easy Sound-Teacher on the right side of each sound slot. Values between 10 and 300 % (in relation to the original wav-file) are possible.

If more than one option to control the volume are used at the same time, then the lowest set volume always controls the maximum volume at the model.

With the "Mute - completely" function, the complete sound output of the module can be switched off.

The volume of the engine sound is set to 0 with the "Mute - engine sound" function.

The volume of the engine sound is always set to 0 while the warnings "Charge battery", "Undervoltage" and "Overcurrent" are being played.

Reduced engine sound volume

During operation, you can switch to a reduced volume (0 - 100% adjustable) for the engine sound. This can be useful, for example, so that additional sounds (such as radio messages) or music via the WAV player are not "drowned" in the engine noise and can be better understood.

With a value of 0%, the engine sound is switched off completely as soon as you switch to the reduced engine sound volume. At 100%, the volume does not change. The value always refers to the currently set volume of the sound module as a percentage.

There are 2 ways to switch to the reduced driving sound volume:

- Activate the "reduced driving sound volume" function via the transmitter or a function sequence
- With the WAV player, you can optionally set in the Sound-Teacher whether or not to switch to the reduced driving sound volume during playback

General notes to volume

Please note that the sound files you transfer to the SFR-1 should have an optimal modulation/volume. Common mistakes are far too quiet recordings that can not be played properly.

Sounds

All sounds are stored at the SFR-1 with our software SFR-1 Sound-Teacher, in so called „slots“.

You don't have to use every slot. If you don't want e.g. any starting-noise, just keep the starting-noise slot free.

In both slots for “Idling noise“ and “FG1“ (engine sound) you should place a sound, otherwise no sound in standing and driving is played.

Here an overview, which sounds in which slots, can be stored:

Sound-Slots
Engine start sound coldstart / warmstart
Idle sound
Vehicle start sound (idling → drive)
Vehicle stop sound (drive → idling)
Engine stop sound
Engine sound FG1 - 5 (different types: slow down, normal and speed up)
Shift sounds between FG1 - FG5
Reverse warning
Brake sound
Cornering squeak
Indicator sound
Turn warning left / right
Engine sound 2: Engine start/stop sound, idle sound, vehicle start/stop, engine sound
Additional sounds 1 – 30
Sound from servo 1 – 4 left / right
Sound from LM servo 1 – 4 left / right
Sound from LM motor
Charge battery sound
Undervoltage sound
Overcurrent sound
Random sound 1 - 8
Tracks 1-30 for WAV-Player

Optionally, the engine sound for driving backward can be different from the sound driving forward. You can put sounds in these slots, but you don't have to. If the slot for driving backward is empty, the sound module will play the normal engine sound. Using slots for driving backward sounds only make sense if the sounds differ from driving forwards.

Engine sound

The engine sound consists of several single sounds. Normally there is an engine starting sound, an idling sound, a driving sound and an engine stopping sound. This module also offers the possibility to imitate up to five different driving sounds (for example for gears), up to eight change sounds between the driving sounds (for example when you change the gears), a reverse warning sound, a breaking sound and cornering squeak.

All engine sounds (therefore also the reverse warning and brake sound) are played only when the engine sound is switched on (see page 23).

Start engine noise (cold- and warmstart)

The start engine sound is played when the engine sound is switched on. The motor is not activated while the start engine noise is playing. After the starting sound is played, the sound changes into the idle sound.

If the engine sound is switched on and the vehicle is already in motion, the starting sound will skip and the module directly plays the engine sound.

As an option, two different engine start sound can be used. The engine coldstart sound (e.g. the starting takes longer, until the engine runs smoothly) and the engine start sound for a warmstart (engine starts immediately). Which starting sound is played, depends on how long the engine was running before. This time can be configured in the Sound-Teacher. (Configuration → Engine sound → Time for warmstart).

If you don't need two different engine start sounds, you can use one of the two slots for your engine start sound. The sound module always plays the sound slot, which is filled with a sound.

Idle sound

The idle sound is always played when the vehicle is in idle. The sound is played in an endless loop. Therefore just a short sound (approx. 1-5s) is required for this sound slot. In general the longer the sounds file, the better the quality of the idle noise.

Vehicle start sound

The starting sound is played uniquely when the vehicle sets off (idle → drive).

Vehicle stop sound

The stopping sound is played once as soon as the vehicle stops (drive → idle).

Engine stop sound

The engine stopping sound is played when the engine sound is switched off.

Reverse warning

The reverse warning sound is played when the vehicle drives backward. This could be e.g. the warning beeping of a truck. The reverse warning sound is mixed/added to the engine sound.

The reverse warning can also be temporarily deactivated via the radio using the “Disable reversing warning sound” function.

Brake sound

The brake sound is played when the driving speed is reduced.

Cornering squeak

The sound for the cornering squeak is played, as soon as the model turns. The threshold level is configured in the Sound-Teacher (Configuration → Engine sound → Engine sound).

Indicator sound

The indicator sound is played when the vehicle signals. The indicator sound is mixed/added to the engine sound.

Engine sound / Gears FG1 - FG5

The engine sound is always played in an endless loop as long as the model moves. The playing speed depends on the driving speed of the vehicle. The SFR-1 recognizes how fast the vehicle moves, and plays the engine sound in the corresponding speed. The relation between driving and sound speed can be set in the driving sound diagram (see page 93).

You can also set with the Sound-Teacher how many different sounds should be used for driving forward and backward. This could be for instance sounds for different gears for a truck or you can choose different driving sounds for each driving speed (e.g. slow, normal and fast).

Please keep in mind; the “gears” are just generated by the SFR-1 and not through a mechanic gearshift. Yet it is not possible to activate the different sounds through an engine control or a real gearshift.

For each driving sound FG1 – FG5 you can use three different settings (normal, slow down and speed up). The latter options are just additional to generate a more authentic sound but in most cases the “normal” sound is sufficient.

If you use the sound slot “slow down” and the model brakes, the driving sound switches automatically from “FGx normal” to “FGx slow down”. The same happens when the model accelerates and the sound slot “speed up” is used.

To divide the entire speed range into sections for up to five engine sounds/gears you can use the engine sound diagram (see page 93).

Sounds for changing driving sounds / gears

If you use more than one driving sound / gear for your driving sound you can also use sounds to simulate the changing between the different driving sounds / gears. When you change the driving sound / gear the changing noise will be played.

Furthermore you can differentiate between acceleration- and deceleration sounds and therefore use for example different sounds for changing the gear from FG1 to FG2 and another for switching from FG2 to FG1.

The changing sound will always be played once and completely when the driving sound / gear is changed. For this reason the sound should be short (e.g. 1s). Otherwise, it might occur for example that the model is already standing but the changing sound is still played.

How to open sound files

In the folder "SFR-1 Sounds", on the supplied DVD-ROM, you will find some exemplary sounds for different vehicle types. In order to store a new sound on the SFR-1, start the program "SFR-1 Sound-Teacher", open a *.sfr project file (Menu "File" → Open project) in the respective folder and save the project files on the SD-card.

The USM-RC-2 sound projects are compatible with the SFR-1. To open a USM-RC-2 file you have to change the shown data type in the „Open“ window to „All files (*.*)“.

To make your model unique, individual and realistic all sounds can be edited and compiled individually, for example with the software Audacity.

For an easy start we recommend to use one of the ready sound projects and adapt it to your requirements step by step.

Turning on/off engine sound

The SFR-1 can only play an engine sound, if it has been switched on before.

There are different ways to switch on the engine sound:

Using a proportional channel (X2/3 - X2/6) to switch on engine sound:

The engine sound can be switched on and off via a control on the radio (stick / slider / switch / rotary potentiometer). The corresponding receiver output must be connected with a servo patch cable to a proportional input (Prop # 3 - # 6) of the sound module.

The proportional channel must be configured in the Sound-Teacher under Configuration → Proportional channels → Function "Engine sound on/off". If the proportional channel is brought in this area (A -D), the engine sound is switched on or off.

Using nautic-mode on proportional channel #3 (X2/3) and #4 (X2/4) to switch on engine sound:

If you have a nautic switch unit installed in your receiver, you can assign the function "engine sound on/off" to a nautic switch (Configuration → Nautic/multiswitch) to turn the engine sound on or off with the selected switch (see page 35).

Using EKMFA-mode on proportional channel #3 (X2/3) to switch on engine sound:

With the One-channel multi-function selection (EKMFA) you can nearly control the whole sound module with only one free channel of the transmitter. "Counting" (and pressing the joystick a corresponding number of times) is used to determine, which function is triggered. In the Sound-Teacher you can set up, how often the joystick must be pressed, to turn on/off the engine sound (see page **Fehler! Textmarke nicht definiert.**).

Turn on engine sound automatically by motion:

Is this option activated, the engine sound is switched on automatically, as soon as you accelerate the first time (that means for example moving the joystick out of the neutral position) (see page 64). The engine sound keeps switched on as long as you are driving. If the model is stopped, the engine sound will be turned off after an adjustable time (e.g. 10 seconds). If you start driving again, the sound will be switched on again. This method has the advantage, that no additional channel (or switch) in the transmitter are needed to activate the engine sound.

Engine sound 2

In addition to the actual engine/driving sound; a second speed-dependent sound can also be played. However, this second engine sound does not offer as many sound slots/options as the normal engine sound.

The engine sound 2 must not necessarily be an engine sound that is played while "driving". Generally all speed adjustable sounds can be used for any kind of movement. This can for example be a speed-dependent turret rotation of a tank or the sound of a hydraulic pump in a construction vehicle.

Following sounds are available for the engine sound 2:

- Engine start sound 2
- Idle sound 2
- Motion start 2 sound
- Engine sound 2 (speed dependent)
- Motion stop 2 sound
- Engine stop 2 sound

The functions of engine sound 2 correspond in principle with those of the normal engine sound (see page 21). Depending on type of movement, you do not have to use all of these sound slots. For example, in case of a tank turret rotation, only the

sounds for motion starting, driving, and motion stopping are necessary because there are no idle and engine start/stop sounds when turning a tank turret.

The speed for engine sound 2, can be controlled with any proportional channel. Which channel, can be set in the Sound-Teacher (see page 66).

There are 2 options to activate/deactivate engine sound 2:

- by selecting the function "Engine Sound 2 on/off" for a position in "Configuration" - "Proportional channels", "Nautic 1", "Nautic 2", or "EKMFA mode"
- by using the option "Turn on sound automatically by motion" in "Configuration" - "Engine Sound 2".

Furthermore, there is also the option when starting engine sound 2, to shut off the normal engine sound automatically - and vice versa. Thus it is easy possible to change between two different engine sounds.

However, functions as reversing sound/light or brake sound/light are not directly controlled by driving sound 2. These functions continue to be controlled through the throttle channel at the normal engine sound.

Functions of SFR-1

Additionally to the driving sound, the SFR-1 offers more features, which can be controlled by the remote control or the switching-inputs.

Overview of all the functions:

Additional sounds	<ul style="list-style-type: none"> • Trigger additional sounds 1 - 30
Outputs / Lighting functions	<ul style="list-style-type: none"> • Switching the outputs 1 - 16 • Output sequence 1 - 8 • Light switch +/- • Parking light • Low beam headlight • High beam headlight / headlight flasher • Front fog light • Rear fog light • Indicator left • Indicator right • Hazard lights • Driving Backwards • Brake light • Locomotive: Driving light • Ship: At anchor • Ship: In operation • Ship: Aground • Ship: Restricted in ability to manoeuvre • Ship: Unable to manoeuvre

	<ul style="list-style-type: none"> • Ship: Constrained by draught • Ship: Towing • Ship: Assisting • Ship: Fishing • Smoke generator • Turn off all outputs
Speed controller	<ul style="list-style-type: none"> • Change of direction • Throttle curve 2 • Load regulation on / off • Cruise control on / off • Mass inertia light / medium / heavy / off • Steering limit off • Freewheel • Start setup
Other	<ul style="list-style-type: none"> • No function • Engine sound on/off • Engine sound 2 on/off • Random sound enable • Volume + and – • Mute – completely • Mute – engine sound • Reduced engine sound volume • Play with the throttle • Engine sound rpm change • Disable reversing sound • Software-Reset (rebooting the module) • Multi function 1 - 4 • Function sequences 1 - 8
WAV-Player	<ul style="list-style-type: none"> • Play / Stop • Pause • Track fwd • Track rev • Random
Servo functions	<ul style="list-style-type: none"> • Servo 1/2 position 1 - 4 • Servo 1/2 sequence
Functions for the light modules SM-IR16-2, LM-IR-16-4 and LM-BT-16-4	<ul style="list-style-type: none"> • Servo 1 - 2 position 1 – 2 • Servo 3 - 4 position 1 – 2 (only LM-xx-16-4) • Motor up / down (only LM-xx-16-4) • Rotating beacon • Blinker lights/flash lights • Chaser light • Transmission off • Activate road train ID 1 - 7 (only LM-xx-16-4)

All functions can be triggered by the proportional channels, the Nautic-mode and the EKMFA-mode. The assignment in the Sound-Teacher is very flexible.

Additional sounds 1 - 30

In addition to the engine sound, the SFR-1 can play up to 30 additional sounds. Typical sounds are e.g. horns, hydraulic and pneumatic noises, warning horns, shooting noises, Songs, radio calls, and so on. There are nearly no limits set to your imaginations.

To play an additional sound, it must be started over a start impuls. This can be done by using the proportional channels, the Nautic-mode or the EKMFA-mode.

Additional sounds 1 and 2 offer a special feature:

Each of these sounds consists of 3 single sound slots. When the additional sound 1 is started, the slot **“start”** is played first. Then the sound changes to the slot **“loop”** and plays this slot in an endless loop so long as the start signal for the additional sound 1 is still present. When the start signal for additional sound 1 disappears, the slot **“stop”** is played uniquely. Additional sound 2 works in the same way.

In this way, a sound like a ship horn with variable length (without a hard cut at the end), can be realized. Also for example a MG fire can be fitted with a great reverberation.

The start and stop slots are only options that can be used. You can let these slots also free.

For additional sounds 3-30 various play-back modes can be set up using the USM-RC Sound-Teacher. Thereby it is possible to fine-tune every additional sound to produce a perfect match to your particular mode.

The possible playback modes are now described. They differ also in that way, how the sound is started.

Triggering with proportional channels (as memory configured) or with EKMFA-mode:

Mode	Function
Once / complete	When the sound is started, it is played exactly <u>once</u> , from start to finish, and then it stops. It is not possible to halt the sound prematurely; it is <u>always</u> played completely.
Once / immed. stop	When the sound is started, it is played exactly <u>once</u> , from start to finish, and then stops. However, if the sound is started again while it is already or still running, the sound is <u>stopped immediately</u> .
Loop / complete	When the sound is started, it is played again and again from start to finish in an <u>endless loop</u> . To switch the sound off again it must be virtually “started” again. The sound then runs from start to finish once more <u>completely</u> , and then it stops.

Loop / immed. stop	When the sound is started, it is played again and again from start to finish in an <u>endless loop</u> . To switch the sound off it must be virtually “started” again. The sound then <u>stops immediately</u> .
--------------------	--

Triggering with proportional channels (as static configured) or nautic-mode:

Mode	Function
Once / complete	When the sound is started, it is played exactly <u>once</u> , from start to finish, and then it stops. It is not possible to halt the sound prematurely; it is <u>always</u> played completely.
Once / immed. stop	When the sound is started, it is played exactly <u>once</u> , from start to finish, and then stops. However, if the input is switched off while it is still running, the sound is then <u>stopped immediately</u> .
Loop / complete	When the input is switched on, the sound is played again and again from start to finish in an <u>endless loop</u> . If the input is switched off again, the sound runs from start to finish once more <u>completely</u> , and then stops.
Loop / immed. stop	When the input is switched on, the sound is played again and again from start to finish in an <u>endless loop</u> . If the input is switched off again, the sound then <u>stops immediately</u> .

Random sounds

Up to eight random sounds can be played with the SFR-1. The frequency of the sound play-back is determined by a random generator. The time spans (min/max) can be programmed by 1 – 999 s for every sound separately. In the same way the conditions (idling/drive - engine sound on/off) the sound should be played can be programmed for each of the 8 random sounds. For instance you can define that at a tank a randomized “chain squeaking” is played, but only during the drive and not in the idling.

Because the 8 random sounds run completely independent from each other, it can happen that two or three of the random sounds are played simultaneously. This can be blocked by activating the option "Don't play 2 random sounds at the same time".

In your Sound-Teacher you can also determine whether the random sounds should generally be enabled or you can activate/deactivate random sounds with your RC by setting the function "Random sound enable" for a position.

WAV-Player

The WAV-Player of the SFR-1 can be imagined as a kind of “MP3 player“. The difference is that the module plays WAV files instead of MP3 files.

The WAV-Player is primarily intended to play songs. But of course other sounds can be played, too.

In the Sound-Teacher, up to 30 tracks can be stored for the WAV-Player.

The WAV-Player is controlled by five functions:

- Play / Stop
- Pause
- Track forward
- Track reverse
- Random

These five functions can be done by using the proportional channels, the Nautic-mode or the EKMFA-mode.

Function “Play / Stop“:

If this function is activated, the WAV-Player will start playback of the first track. If this function is activated again, the playback will be stopped. The playback of a track starts always from the beginning of the track.

If a track is played to the end, the player will jump to the next track. With the option “Stop play after each track“ you can choose, if the next track will be started automatically, or if the playback just stops.

After track 30 the internal counter will jump back to track 1.

By the way, the sound module always remembers the current track number. The next time the power supply is switched on, this track number "will be loaded" again. If any changes are made to the SD card via the Sound-Teacher, the track counter will be reset to track number one.

Function „Pause“:

If you activate the function "Pause", the playback of the current track pauses. Another activation of this function starts the playback at the same position again.

Function "Track fwd":

With this function, the player will jump to the next available track. It does not matter, if there are any gaps in the track list.

Was previously the random function enabled, a new, random track will be played.

Function "Track rev":

This function is normally used to go to the previous track. If this function is triggered while the current track is played for more than five seconds, the WAV-Player will not jump to the previous track; however it will go to the beginning of the current track.

Was previously the random function enabled, a new, random track will be played.

Function „Random“:

With this function a sound from a tracklist is randomly chosen and played. If you activate the function „Random“ while a track is still playing, this title stops and a new one starts.

Functional assignment at proportional channels

The proportional channel #1 is only responsible for the speed recognition.

The remaining channels can be configured in the Sound-Teacher with different functions.

To occupy the proportional channels with several functions, these channels are split into five areas "A, B, N, C and D". These areas represent the possible positions of a joy-stick.

The area N is the neutral position that is the center position of the joy-stick.

The same principle is also valid for a horizontal joy-stick. The area A is in this case to the left and area D to the right.

However, only areas A, N and D can be controlled with a 3-position switch. Areas B and C have no function here.

The areas can also adjusted/optimized to your remote control, by setting the four thresholds in the Sound-Teacher.

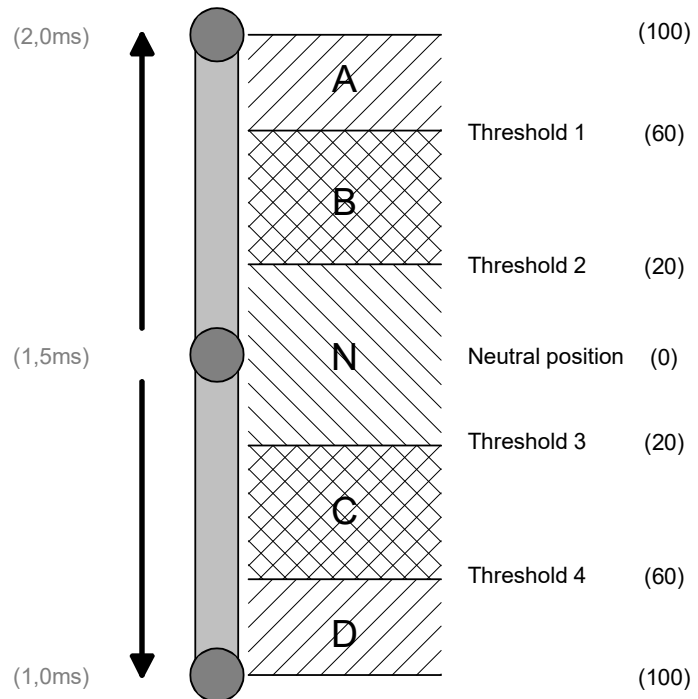

Assignment of channels:

Area	Functions		
	in position (>0,5s)	short in position (0,5-2,0s)	long in position (>2,0s)
A	function on (static)	function on/off (memory)	function on/off (memory)
B	function on (static)	function on/off (memory)	function on/off (memory)
C	function on (static)	function on/off (memory)	function on/off (memory)
D	function on (static)	function on/off (memory)	function on/off (memory)

Theoretically it is possible to assign 12 functions to one proportional channel. But in practical terms this doesn't make sense. You should avoid using an area with the static and the memory function at the same time.

Difference between static and memory function:

Static	Memory
<p>If a function is defined as static, it will be switched on <u>as long as</u> the joy-stick is in the corresponding area. If you leave the area, the function will be switched off again.</p>	<p>If a function is defined as memory and you move the joy-stick for the specified time (short or long) in the corresponding area, it will be switched on. If you leave the area, the function <u>remains</u> switched on (it is saved). It remains on, until the the joy-stick is moved in the corresponding area <u>again</u>. Exceptional are additional sounds with the setting "once" in "Additional sound". Despite a memory setting in "Configuration" the sound is played only once.</p>

You can read on page 25, which functions can be assigned to the 4 areas A, B, C and D.

Proportional channel #1

Channel #1 is used for the speed information, in order to play the engine sounds speed dependent.

In order to play the correct driving sound, the neutral position of channel #1 must be correctly set. On page 16 you can see how the setting can be used.

Proportional channel #2

In the standard setting, the channel #2 is used for steering. However, it is possible to deactivate the steering function (Configuration → General) and use the channel as a „normal“ proportional channel.

Proportional channel #3

Channel #3 is used to trigger functions via EKMFA mode and Nautic 1.

Proportional channel #4

Nautic/multiswitch module Nautic 2 can be activated at channel #4.

Proportional channel #6

Sum signals, such as S-BUS, SUMD and i-BUS are received via to channel #6. The channel can also be used as a normal proportional channel. The Bluetooth controller BTC-1 is also connected to Prop # 6.

Neutral position of channels

In general, remote control manufacturer do not define a standard neutral position, therefore the neutral positions for the channels #1 - #6 are set up with the teaching function, see page 16.

Alternatively, a "normal" assignment (function triggering over the areas A, B, C and D) of the channels # 2 - # 6 are of course also possible.

Hint:

The diagnosis (see page 96) can be used to check which values the sound module receives from the radio. This can be very helpful when troubleshooting.

Stick simulation via switches or buttons

To use the functions of the proportional channels #2 - #8 conveniently, you can simulate the different potentiometer positions of a stick, through a simple button press. If you press the button S1, a stick position is simulated for position A.

Often the available sticks are already taken by other functions, but mostly the remote control has still other free channels. This schematic can be used for the channels to activate additional functions.

You need only six resistors and four switches for each channel (or two reversing switches with middle position). The small circuit can be easily built on a strip board.

With the indicated resistors values, this schematic works with all standard remote controls. If needed, you can also configure the thresholds of the five areas in the Sound-Teacher.

How and where this schematic is connected in the remote control, is unfortunately differs according to the radio type.

In some (Robbe/Futaba) remote controls an additional 68k ohm resistor is necessary, which has to be placed in the "S"- wire.

Hint:

Here again, we recommend using the diagnosis to check the constuction.

You can buy this circuit as fully constructed module from us:

[SMS-R](#) (for Robbe) and [SMS-G](#) (for Graupner and all other manufacturers).

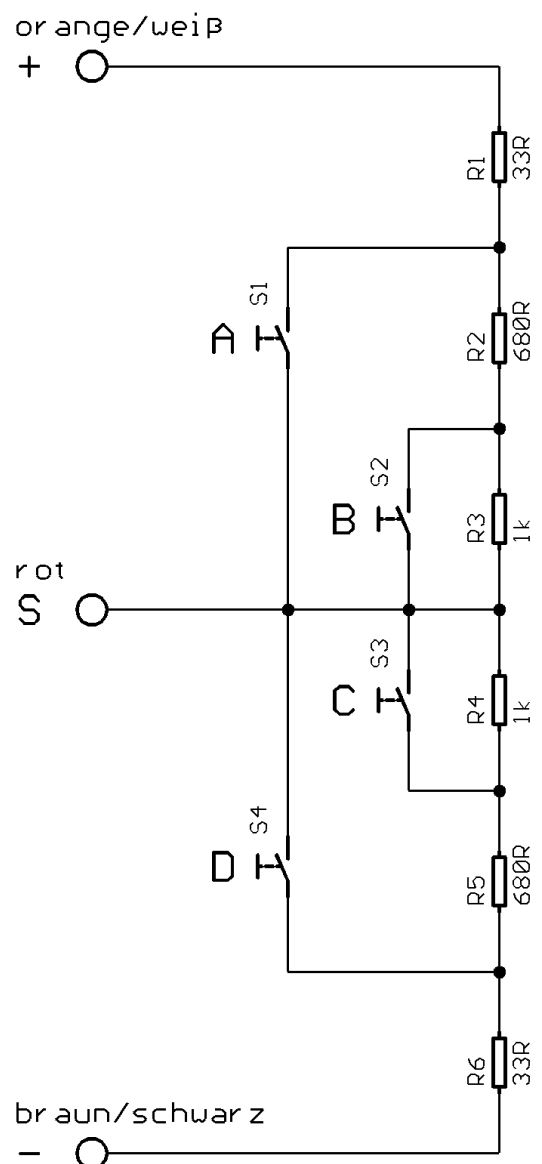

Nautic mode / multiswitch mode

To use the nautic/multiswitch mode it must be activated in the Sound-Teacher under „Nautic 1“ or ”Nautic 2“.

The nautic/multiswitch mode is probably the most convenient method of operating the SFR-1.

The SFR-1 supports following switch modules (and modules compatible with them):

- BEIER-Electronic NMS-16-R, NMS-16-G and NMS-24-G
- BEIER-Electronic EMS-16-R, EMS-16-G and EMS-24-G
- BEIER-Electronic MSC-8-C, MSC-10-C and MSC-8-C-LCD
- Graupner Nautic-Expert Modul (Nr. 4108) and Multikanal
- Robbe Multi-Switch Module (Nr. 8084, 8101, 8413, F1511)
- Mergen/CP 12-Kanal and 16-Kanal Multiswitch

You can install up to two switch modules in your transmitter to control functions. With available space they can be built directly into the remote control or into an external housing (available in our shop).

Proportional channel #3 (X2/3 nautic 1) and/or channel #4 (X2/4 nautic 2) are connected to the receiver channel with servo patch cables.

Some of the latest remote controls include a **“software nautic module”**, such as Multikanal (multichannel) by Graupner. In most of these cases, all switches are transferred by one channel and no additional hardware switch module is necessary. Please refer to the operating instructions supplied with your transmitter for further details.

To each switch position different functions can be assigned in the Sound-Teacher (see page 70). If the memory function is active, the function is switched on or off when the switch is operated, and remains in that state until the switch is in the same position a second time.

With correctly received data from the switch module, the blue LED on the SFR-1 always flashes at regular intervals.
Exception: At EMS modules, the LED flashes only as long as a switch is triggered.

If the blue LED is not flashing regularly, or in case the nautic switches do not work at all, please check the settings at your transmitter. If you are unsure about this, please read the operating instructions supplied with your transmitter, as they generally provide information on the settings required for Nautic modules (e.g. servo travel at maximum).

In our BEIER-Electronic forum (FAQ), you will find a step by step guide in German for troubleshooting:

Hilfe, mein Nautic-/Multiswitchmodul funktioniert nicht

<https://www.beier-electronic.de/modellbau/forum/viewtopic.php?f=8&t=744>

If you are using a Jeti Duplex 2.4GHz, the "output period" of the receiver must be set on "byTransmitter" by the Jeti-Box. Other important setting: ATV High Limit: 2,20 ms, ATV Low Limit: 0,80 ms.

One-channel multi-function selection (EKMFA)

To use the EKMFA mode it must be activated in the Sound-Teacher.

With the "One-channel multi-function selection" (EKMFA) you can control up to 30 functions of the SFR-1 with only one proportional channel (channel #3).

You can assign in the Sound-Teacher the functions you would like to trigger with the EKMFA-mode (see page 71).

To trigger a particular sound or function, the transmitter switch or joy-stick must be moved from position N to position A or D for a certain number.

The last „function“ is always stored, enabling you to repeat the last sound or the last function as many times as you wish, without counting once more. Simply hold the joy-stick for one second in the position **B**, or **C** to repeat the last sound.

In order to switch the 16 outputs directly, they must be configured in the Sound-Teacher as "**static**", "**flashing**" or "**pulse**". An output that is configured e.g. as reversing or brake light, cannot be switched on.

Sum signals S-BUS, SUMD/SUMD3 and i-BUS

With the SFR-1 it is possible to evaluate the sum signals „S-BUS“, „SUMD/SUMD3“ and „i-BUS“ of the receiver. **Up to 16 proportional channels can be transmitted via only one connection from the receiver to the SFR-1.** In order to use sum signals, the receiver must be suitable for sum signals and an activation in the radio might be necessary.

Using the sum signal up to 16 fully functional proportional channels, instead of 6, can be used to control functions.

The sum signal output of the receiver is connected to „**Prop #6**“ (**X2/6**) at the SFR-1.

If the SFR-1 receives a correct sum signal, the blue LED will flash at regular intervals.

Using the Sound-Teacher all 16 channels of the sum signal can be assigned to one of the 16 proportional channels of the SFR-1.

It is important to use Prop #1 at the SFR-1 for the throttle channel of the transmitter.

Digital switches at sum signal SUMD3

With the sum signal "SUMD3" some remote controls (for example Graupner mz-16, mz-32) can also transmit up to 64 digital switches. Each digital switch can be assigned with a function off the SFR-1 (see page 68). Thus, these digital switches are ideal for controlling the various functions of the SFR-1.

Each digital switch can be set on the transmitter, in the "On/Off", "Pulse" and "Flash" modes.

For the following functions of the SFR-1 the mode "**Pulse**" must be selected:

- Light switch + and Lightswitch -
- All WAV-Player functions (play, pause, track rev / fwd, random)
- Indicator left and indicator right
- All additional sounds, in mode „once“

The default 0.5 s can be retained in the transmitter as pulse time. The pulse time can also be reduced to 0.1 s, which speeds up the transmission a bit.

For all other functions of the SFR-1 the mode "**On/Off**" should be selected.

Switching outputs

The SFR has 16 outputs, which can be used to drive electrical consumer units such as lamps, light-emitting diodes, relays, smoke generators etc. Different switching functions and output types can be attached to the 16 outputs by using the Sound-Teacher (see page 74).

The SFR-1 is always switching the negative pole to each output and thus to the connected load (e.g. LED, lamp, relay). The loads plus pole is connected directly to the supply voltage, or to the black and white cables of the output blocks (collected plus pole).

The intensity (PWM-control) of each output can be configured with the Sound-Teacher by steps of 2%, between 2% and 100%.

If relays or other inductive loads (e.g. motors) should be connected to the switching outputs, free-wheeling diodes must (e.g. 1N4007) be used. For relays, the brightness must be set to 100 %, otherwise the relay "flutters"

The following output types are available:

- Output static on
- Output flashing
- Output as pulse
- Output flickering (sound dependend)
- Daytime running
- Daytime running left

- Daytime running right
- Parking light
- Low beam headlight
- High beam headlight
- Front fog light
- Rear fog light
- Brake light
- Reversing light
- Indicator left
- Indicator right
- Dynamic indicator left
- Dynamic indicator right
- Bending light left
- Bending light right
- Side marker light left
- Side marker light right
- Combined headlight
- Combined rear light
- Combined American rear light left
- Combined American rear light right
- In motion on
- In stationary on
- In stationary and motion on
- At accelerating on
- At driving speed on
- Locomotive: Driving light forward
- Locomotive: Driving light backward
- Ship: All-round light red top
- Ship: All-round light red middle
- Ship: All-round light red bottom
- Ship: All-round light green top
- Ship: All-round light white middle
- Ship: All-round light white bottom
- Ship: 1. Masthead light
- Ship: 2. Masthead light
- Ship: Anchor light
- Ship: Side light
- Ship: Stern light
- Ship: Towing light
- Smoke generator
- Military vehicle: Black out headlamp
- Military vehicle: Disguise rear light
- Military vehicle: Disguise brake light
- Military vehicle: Guidance cross
- Temperature controlled

The output types "Parking light", "Low beam headlight", "High beam headlight", "Fog light", "Rear fog light", "Indicator left", "Indicator right" and all "Combined lights" must be switched on via their "light names", not via the output number!

For example, if the parking light is connected to output 1, to switch on the parking light (via a prop. Channel, nautic / multiswitch, or the light switch), the "Parking light" function must be activated, not the "output 1" function.

Output “Static“ on

An output with this setup can be switched on using a sound, a proportional channel, a nautic switch or the EKMFA-mode.

The output is always switched on as long as a sound is played, with which the output is activated in the Sound-Teacher or the output is switched on with one of the free allocable functions.

Output “Flashing“ on

An output with this setup can be switched on using a sound, a proportional channel, a nautic switch or the EKMFA-mode.

The output flashes as long as a sound is played, with which the output is activated in the Sound-Teacher or the output is switched on with one of the free allocable functions.

The flashing frequency can be set separately for each output in the Sound-Teacher. The value for the flashing frequency is entered in field “**Option 1**“. Values within the range 1 to 255 can be set: 1 corresponds to the fastest flashing frequency (50 Hz) and 255 the slowest (0.196 Hz).

The flashing frequency can be calculated as following: $f = 1 / (\text{value} \times 0.02)$.

Output as “Pulse“

An output with this setup can be switched on using a sound, a proportional channel, a nautic switch, the EKMFA-mode or a switching-input.

If the output is activated, it will be switched on for a limited period of time and then goes off again. A typical application is a short muzzle flash from a canone.

The pulse duration can be adjusted in the Sound-Teacher. The value for the pulse duration is entered in field “**Option 1**“. Values within the range 1 to 255 can be set: 1 corresponds to the shortest pulse duration (0.1 s) and 255 to the longest pulse duration (25.5 s).

The pulse duration can be calculated by multiplying the entered value with 0.1s. A value of 5 means for example a pulse duration of 0.5 s.

Output “Flickering“ on

An output with this setup can only be switched on using a sound. When this function is selected the outputs flicker at the same rhythm as the sound that is played currently.

This can be used to generate very impressive light effects, such as a simulation of fire or a welding torch.

The Sound-Teacher allows you to adjust the sensitivity of the flicker effect separately for each of the outputs. A value between 1 and 255 can be entered in the field “**Option 1**“. The higher the value the higher the sound volume must be to activate the flicker effect.

Output “Daytime running light“, “Daytime running light left“, “Daytime running light right“

The output for the daytime running light will be switched on, if the parking light and the low beam headlight are not switched on. When the parking light or low beam headlight are turned on, the brightness changes to the value of **"Option 1"**. If this value is 0, the daytime running light is switched off when the parking light or low beam headlight are switched on. When the indicators are activated, the brightness of the daytime running light is switched to the value of **"Option 2"**.

The output types "Daytime running light left" and "Daytime running light right" behave in the same way as the "Daytime running light" type, but here only the brightness of the daytime running light on the side that is blinking is changed (value of „Option 2“) when the indicators are activated.

“Parking light“, “Low beam headlight“, “High beam headlight“, “Front fog light“ and “Rear fog light“ outputs

The outputs for these lights are switched on as soon as the corresponding function is switched on. The function can be switched on using a proportional channel, a nautic switch or the EKMFA-mode.

Of course, you do not have to keep to this order. That means for example if you don't need a rear fog light, you can connect something else to the output.

The lights can be switches with the programmable light switch under "Configuration", "Outputs" and "Light switch" (see page 77).

Output “Reversing light“

The output for the reverse driving light is always switched on when the vehicle runs backwards.

Output “Brake light“

The brake light is always shortly turned on when the driving speed is reduced substantial. The sensitiveness can be configured in the Sound-Teacher (see page 75).

Outputs “Indicator left“ and “Indicator right“

The outputs for the indicators can be switched on using proportional channel #2, a nautic switch or the EKMFA-mode.

If “American indicator mode” is selected, the indicator lights will come on, as soon as the parking light is switched on. The intensity for the “indicator parking light” can be adjusted in **“Option 1“** (e.g. 10 %).

If **hazard lights** are switched on, both indicators will start flashing at the same time.

At Configuration → Outputs → Output options additional settings can be made.

Outputs "Dynamic indicator left" and "Dynamic indicator right"

Modern vehicles often have "dynamic indicators". This means that the indicator consists not only of one lamp/LED, but of several, which are controlled like a kind of running light. The USM-RC-3 can emulate this effect. However, 3 separate outputs for 3 LEDs are required on each side (left and right) - a total of 6 outputs!

The LEDs are arranged on the vehicle as follows:



The "Dynamic Indicator #1" output is always the inner of the 3 LEDs, the "Dynamic Indicator #3" output is the outer of the 3 LEDs.

The dynamic indicator is activated in exactly the same way as the normal indicators signal, i.e. via the "Indicator left", "Indicator right" and "Hazard lights" functions or via the automatic turn signal function when steering.

If the "dynamic indicator" (e.g. on the towing vehicle) and also a "normal" indicator (e.g. on the trailer) are to be used on the model, the "Dynamic indicator #1" output can also be used for a normal indicator. So there are no extra outputs for the normal indicators necessary.

Outputs "Bending light left" and "Bending light right"

These outputs can be turned on at cornering. There are 2 ways in which the bending lights can be turned on:

1. By steering on proportional channel #2 (X2/2)
2. By the indicator signal
3. By driving backwards

For more information about these two options, please look on the page 75. The bending lights can optionally also be front fog lights and can then also be switched by the function "Front fog light". The switching on and off of the bending lights is not immediate, but with a dimming function.

Outputs "Side marker light left" and "Side marker light right"

The outputs for the side marker lights light up with the value of "**Intensity**" as soon as the parking lights or low beams are switched on. If the indicators or hazard warning lights are switched on, the corresponding side marker lights will blink. The brightness for the blinking is set in the Sound-Teacher with "**Option 1**".

Output „Combined headlight“

Using the combined headlight, "**parking light**", "**low beam headlight**" and "**high beam headlight**" can be switched using just one output.

The Intensity for each of the 3 lights can be adjusted separately:

The intensity of the parking light is entered under "**Intensity**" (e.g. 10 %).

The intensity of the low beam headlight is entered under "**Option 1**" (e.g. 30 %).

The intensity of the high beam headlight is entered under "**Option 2**" (e.g. 60 %).

However, it should be noted that these 3 intensities are added, if more than one light is switched on. Summing up, you should avoid a value that is over 100 %.

Output “Combined rear light“

Using the combined rear light, “**parking light“**, “**brake light“** and “**rear fog light“** can be switched using just one output.

The Intensity for each of the three lights can be adjusted separately:
The intensity of the parking light is entered under “**Intensity“** (e.g. 10 %).
The intensity of the brake light is entered under “**Option 1“** (e.g. 30 %).
The intensity of the rear fog light is entered under “**Option 2“** (e.g. 60 %).

However, it should be noted that these three intensities are added, if more than one light is switched on. Summing up, you should avoid a value that is over 100 %.

Output „Combined American rear light left/right“

This setting switches three light functions, namely „parking light“, “brake light” and “indicator right” respectively “indicator left” via only one output.

For each of this light functions you can set the intensity separately.
The intensity for “Parking light” is set at “Intensity” for example 10 %.
The intensity for “Brake light” is set at “Option 1” for example 100 %.
The intensity for “Indicator light” is set at “Option 2” for example 50 %.

In contrast to other combined lights, the intensities are not summarised!

Output „Locomotive – driving light forward/backward“

These two output types are triggered via the function "Locomotive - Driving light". If the locomotive is moving forwards, the output "Locomotive - Driving light forward" is activated. If the locomotive runs backwards, the output "Locomotive - Driving light backward" is activated. In stand always the last switched output remains switched on.

Output “In motion on“

This output is always switched on when the model is in motion, whether it is moving forwards or in reverse.

Output “In stationary on“

This output is always switched on when the model is stationary.

Output „Stationary/Motion“

With this function the output is always active, regardless of whether the model is moving or not. The value “Intensity” defines the light intensity during standing. “Option 1” defines the intensity when the model is in motion (0 - 100 %). The change between both light intensities is executed smoothly.

Output “At accelerating on“

This output is always switched on briefly as soon as the model accelerates from standing.

Output “At driving speed on“

This output is switched on when the model exceeds a defined running speed level. This level is entered under “**Option 1**“.

Outputs for ships

With these outputs the lights of ships can be authentically simulated. The lights are controlled using this logic-table:

	Output	All-round light red top	All-round light red middle	All-round light red bottom	All-round light green top	All-round light white middle	All-round light white bottom	1. Masthead light	2. Masthead light	Anchor light	Side light	Stern light	Towing light
Function													
At anchor										☀			
Aground		☀		☀						☀			
In operation								☀			☀	☀	
Restricted in ability to manoeuvre		☀		☀		☀		☼			☼	☼	
Unable to manoeuvre		☀		☀							☼	☼	
Constrained by draught		☀	☀	☀				☀			☀	☀	
Towing								☼	☀		☼	☼	☀
Assisting								☼	☀		☼	☼	
Fishing					☀		☀	☼			☼	☼	

☀ = output is active

☼ = output is only active, if the ship is in operation

This table is fixed stored in the firmware and can not be changed!

Example:

If the function “In operation“ is active, the outputs which are configured as “1. Masthead“, “Side light“ and “Stern light“ are switched on.

If you want to use light functions, the outputs must be configured (which light is connected to which output) and secondly the functions must be allocated to the control elements (e.g. nautic switch) of the transmitter. You should use “Memory“ functions for this.

Some of the available functions are mutually exclusive. For example, a ship cannot be “At anchor“ and be “In operation“ at the same time.

The relationship between light functions and outputs (see table), are fixed and can not be changed!

The condition "in operation" can either be manually switched on with the function "Ship: in operation" (e.g. by using a Nautic switch), or automatically with the throttle channel on proportional channel #1.

If you want to use the automatic detection of "in operation" or "at anchor", you will have to switch them on in the configuration of the Sound-Teacher (see page 75). If the throttle stick is then not in neutral position (ie. the ship operates), it will be switched to the condition "in operation". If the ship is stopped (throttle stick in neutral), the condition "in operation" will be switched off after an adjustable time and usually it will be switched over to the condition "at anchor". However, if in this moment there is still another condition active, like e.g. "restricted in ability to manoeuvre" or "towing", the condition will remain active and it will only be switched over to "at anchor" until the other condition is switched off.

If the automatic detection of "in operation" or "at anchor" is active, these conditions cannot be switched with the functions "Ship: in operation" and "Ship: at anchor".

Additional informations to lights of ships can be found in the [internet](#).

Output "Smoke generator - heater" and „Smoke generator - fan“

These output types are for connecting a proportional smoke generator. Depending on the state (engine start, idle, accelerating and running speed) of the model, the output is controlled with varying intensity. Thus, smoke emissions (per fan) are produced to suit the particular situation.

With the output type "fan" a trailing can be set (see page 44).

The smoke emissions can be adjusted using the 3 parameters "Intensity", "Option 1" and "Option 2":

- At "**Intensity**" the intensity of the smoke emissions during engine start and acceleration can be set (e.g. 100%).
- At "**Option 1**" the intensity of the smoke emissions while standing (e.g. 20 %) can be adjusted.
- At "**Option 2**" the maximum smoke intensity at **full running speed** (e.g. 90 %) can be defined. The corresponding smoke intensity at each speed level between start and full running speed is calculated automatically.

The output is activated via the the function "Smoke generator on" or automatically when turning on the driving sound (see page 75).

Outputs for military vehicles: „black out headlamp“, „disguise rear light“, „disguise brake light“ und „guidance cross“

These outputs can only be switches with the programmable light switch (see page 77) using the functions "light switch +" and "light switch -".

Output „Temperature controlled“

If the motor output stage requires some cooling with an additional fan, the fan can be controlled via the existing temperature sensor. In Configuration → Outputs → Outputs you can define from which temperature the fan should be switched on ("Option 2") and at which temperature the fan should be switched off again ("Option 1").

Transmission of the outputs to a trailer light module

The outputs 1 - 12 of the SFR-1 can be transmitted to our IR light module [SM-IR-16-2](#) via an infrared signal.

The outputs 1 - 16 of the SFR-1 can be transmitted via infrared signal to our light module [LM-IR-16-4](#) or via Bluetooth to the light module [LM-BT-16-4](#).

Other light modules are not compatible.

Attention:

The outputs 13 - 16 of the SFR-1 can unfortunately not be transferred to the SM-IR-16-2! The outputs 13-16 of the SM-IR-16-2 can only be used for special functions such as flashing or running lights (see manual for the SM-IR-16-2).

Output sequences

You can assign any number of outputs in up to eight sequence groups.

In the Sound-Teacher up to 36 steps can be programmed for each of the eight sequences (see page 79). For every step, you can program which output is switched on and the intensity of the outputs.

Moreover, the duration of every step until it goes on to the next one can be configured.

Is an output sequence enabled, the sequence always takes precedence over the normal function (eg, indicators, parking lights, etc.) of the output. The normal function of the output is switched off during the active sequence.

With these output sequences, the most amazing light effects can be generated.

Examples:

- Rotating lights
- Moving lights
- Modern police flashlights
- Beacon lights for airplanes
- Switching on flickering of fluorescent lamps
- Any flickering lights and flash lights

Servo outputs

The SFR-1 offers two servo outputs (X5/1 and X5/2). The servo outputs deliver usual pulses from 1.000 – 2.000 ms, so you can connect standard servos or speed-controllers. The power supply for these servo outputs is the integrated BEC of the SFR-1.

There are 3 different ways to control the servo outputs:

1. Driving to fixed positions
2. Direct, proportional control via a prop. channel
3. Running through a programmed sequence

Move to fixed positions:

For each servo, up to five positions can be specified in the Sound-Teacher (see page 82), which can be approached via the freely assignable functions of the sound module. The positions have the following names:

- Home position
- Position #1
- Position #2
- Position #3
- Position #4

Direct, proportional control via a prop. Channel:

Any desired prop. Channel can be assigned in the Sound-Teacher, which is to be used for the "direct servo control" (see page 82). The servo then behaves as if it were connected directly to the receiver. However, this makes it easy to play a sound as soon as the servo moves. The servo travel can be scaled with direct control. The scaling range is -100% to +100%. Whereby negative values reverse the direction of the servo. The direct servo control can be deactivated via the "Servo x home position" function. The servo then remains in the home position as long as this function is activated. This is useful, for example, for switchable, steerable axles.

Running a programmed sequence:

A flow sequence can be programmed for each servo output in the Sound-Teacher. Conceivable applications are e.g. a recoil system for a tank or an easy windshield wiper for a truck.

A servo sequence can be triggered with the functions "Servo 1 sequence", "Servo 2 sequence" or with a sound (e.g. a cannon shot). A detailed description of the servo sequence can be found on page 85.

A servo output can only be controlled either to a fix positions or as a sequence. Both versions are not possible at one servo output.

The servo movement can also trigger a sound. The additional sounds "Sound from servo 1/2" are responsible for this. It also distinguishes between left and right movement. So you can play for every direction of running a different sound.

If you don't want sounds while moving the servos, just leave these sound-slots empty.

Function sequences

All functions that can be triggered with the sound module (see page 25) can be compiled to a special function sequence with defined order and time for each step.

More information can be found in this manual starting on page 87.

Voltage monitoring

The connected supply voltage at X1/A+ and X1/A- is measured permanently. If the voltage drops below an adjustable value for longer than ten seconds, different actions can be triggered:

- Playback of a warning sound at empty battery (z.B. „Please load battery“)
- Playback of a warning sound at undervoltage (e.g. „Attention undervoltage“)
- Switch off the sound module
- Switch off all outputs

Some battery types (e.g. LiPo-batteries) should not be subjected to deep discharge, because this can damage the battery! With the help of the integrated voltage monitoring, it is now possible to warn the user.

There are two thresholds in the Sound-Teacher:

- Threshold for charging battery
- Threshold for undervoltage

The thresholds of the voltage monitoring are freely adjustable and lies between 4,5 and 18,0V.

Here is a list with usual values for different battery types:

Battery typ	Battery voltage	Threshold for charging battery	Threshold for voltage monitoring
Nickel-cadmium and nickel-metallhydrid	6,0 V (5 cells)	5,2 V	5,0 V
	7,2 V (6 cells)	6,2 V	6,0 V
	8,4 V (7 cells)	7,2 V	7,0 V
	9,6 V (8 cells)	8,2 V	8,0 V
	10,8 V (9 cells)	9,2 V	9,0 V
	12,0 V (10 cells)	10,2 V	10,0 V
	13,2 V (10 cells)	11,2 V	11,0 V
	14,4 V (12 cells)	12,2 V	12,0 V
	15,6 V (13 cells)	13,2 V	13,0 V
Lead battery	6,0 V (3 cells)	5,2 V	5,0 V
	12,0 V (6 cells)	10,4 V	10,0 V
Lithium-Ionen	7,4 V (2 Zellen)	5,2 V	4,8 V
	11,1 V (3 Zellen)	7,8 V	7,2 V
	14,8 V (4 Zellen)	10,4 V	9,6 V
Lithium-polymer (Lipo)	7,4 V (2 cells)	6,6 V	6,4 V

	11,1 V (3 cells) 14,8 V (4 cells)	9,9 V 13,2 V	9,6 V 12,8 V
Lithium – iron phosphate (LiFe)	6,6 V (2 cells) 9,9 V (3 cells) 13,2 V (4 cells) 16,5 V (5 cells)	5,0 V 7,5 V 10,0 V 12,5 V	4,5 V 6,6 V 8,8 V 11,0 V

These values are only guidelines, the best is to read the user manual of the battery, to find out the exact deep-discharge voltage.

Current monitoring

The current is monitored of all 16 switching-outputs. In case of a detected overcurrent all outputs are switched off in order to protect them from damage.

Nevertheless, the outputs are not completely short circuit proof! Therefore you have to avoid short circuits at the outputs!

If an overcurrent is detected, the additional sound „Sound at overcurrent“ is played (if the slot is not empty) and the red LED on the sound module is also permanently switched on.

The current monitoring can also be optionally deactivated (see page 56). This can be necessary if interference pulses (mostly caused by the motor) influence the current measurement and thus lead to false overcurrent messages. Attention: If the current monitoring is deactivated, there is no longer any overload protection of the outputs!

LEDs on SFR-1

There are three LEDs on the sound module to show different conditions.

Green LED

The green LED always lights up while the supply voltage is connected to X1/A+ and X1/A-.

Red and blue LED

These two LEDs show different conditions and errors.

In nautic mode the blue LED flashes regularly, if the nautic data are transmitted correctly from the receiver.

Status:

Error code	Status / Error	LED green	LED red	LED blue	Actions
1	No SD-card plugged in No data on the SD-card Unable to read SD-card	on	Fast flashing	on	No SD card plugged in, defect SD card or file →
3 - 11	File read or write error	on	Slow flashing	off	Use a new SD card, formatting SD card (FAT 32), transfer project file with Sound-Teacher
12	Error at amplifier	on	12 x slow flashing	off	Get into contact with BEIER-Electronic
15	Overcurrent at switching outputs	on	on	off	Control of connections and sum current of all outputs
16	Undervoltage	on	aus	Slow flashing	Control of battery voltage, charge battery
17	Overtemperature	on	Slow flashing	off	Control and improvement of air circulation and cooling
18	Overcurrent at motor	on	Fast flashing	off	Control of motor and motor connection
	Throttle channel has not been in neutral yet	Slow flashing			Put throttle stick to middle position (neutral)
	Teaching/setup active	Fast flashing			Setup function is active in order to learn all neutral positions
	Teaching/setup active, no signal at throttle channel	Fast flashing	on		Turn on transmitter/remote control, check connection cable at throttle channel
	Nautic/Multiswitch, sum signal or BTC-1 signal correctly received			Fast flashing	Everything OK

Kraftwerk EasyBus lighting boards

The SFR-1 can also directly control the [EasyBus lighting boards](#) from Kraftwerk. This considerably simplifies the connection of the lighting. The signal for the EasyBus lighting boards is available at connector X5/1 of the SFR-1. Attention: Here an [EasyBus adapter](#) with matching connector (servo plug) is needed!

Please note:

The EasyBus lighting boards or the EasyBus adapter have to be connected at X5/1 (Servo 1) of the SFR-1. Therefore, the servo output X5/1 can not be used to connect a servo anymore!

The 16 switching outputs of the SFR-1 can nevertheless be used for further lighting.

The EasyBus lighting boards require at least the software version V4.08 to work with the SFR-1. If the lighting boards have an older software version, they can be updated via the Kraftwerk software "[ControlPanel](#)" and a KLM. Alternatively, the lighting boards can also be sent to Kraftwerk for an update.

If Kraftwerk EasyBus lighting boards are to be connected to the SFR-1, this must be activated in the Sound-Teacher (see page 56). Further settings are not absolutely necessary for the lighting boards. Of course, the behavior of the lighting can still be set under „Configuration“ → „Outputs“ → „Output options“.

With the Kraftwerk EasyBus lighting boards, there are, however, a few slight restrictions that should be noted:

- The lighting boards can not be controlled via output sequences
- The flickering of the lights during starting can not be set by the Sound-Teacher (only via the Kraftwerk [ControlPanel](#))
- The light bulb effect can not be set by the Sound-Teacher (only via the Kraftwerk [ControlPanel](#))
- The xenon effect can not be set by the Sound-Teacher (only via the Kraftwerk [ControlPanel](#))

PC software „SFR-1 Sound-Teacher“

With our software „SFR-1 Sound-Teacher“ the module can be configured and sound files can be transferred to the SD-card.

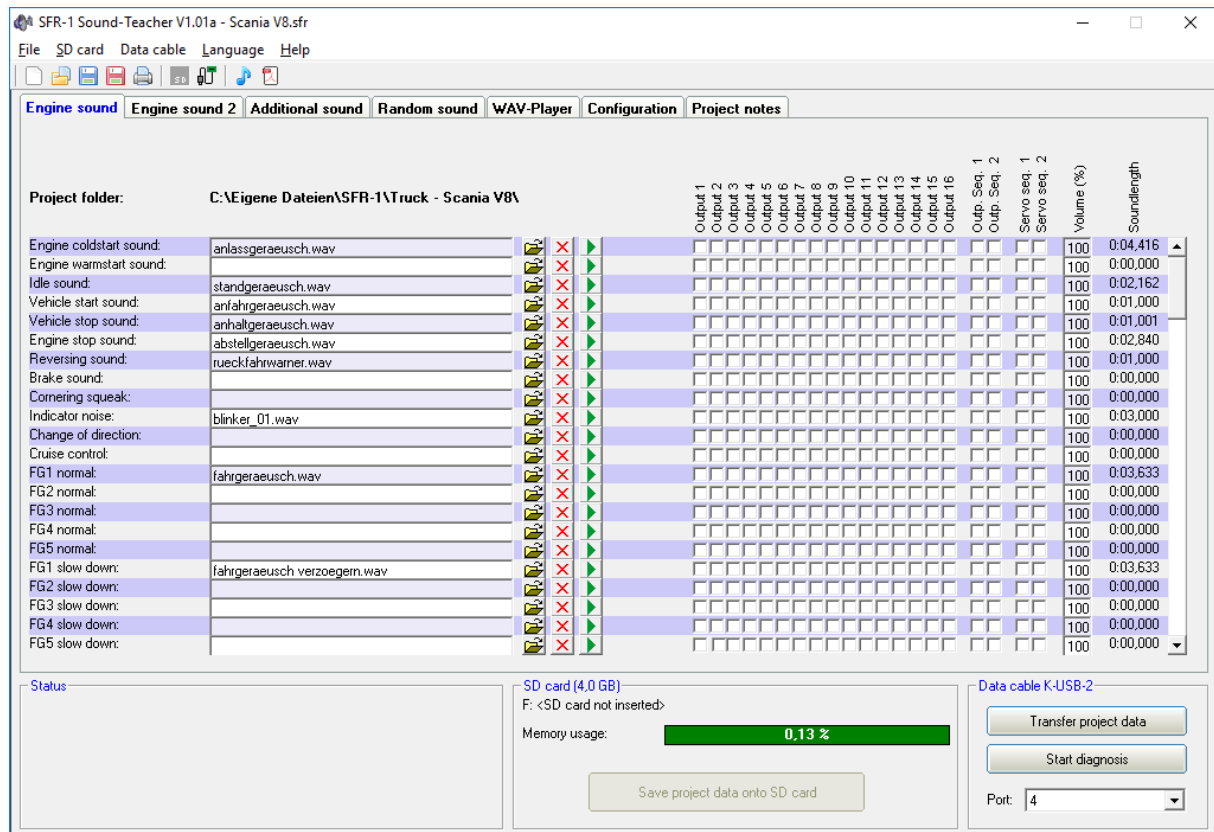

System requirements

- Windows compatible PC
- Windows 2000, NT, XP, Vista, Windows 7, 8, 10 or 11
- about 20 MB of free HD space
- SD-cardreader or a free USB interface (1.0, 1.1, 2.0 or 3.0)
- DVD-ROM drive

Software installation

In most cases the "SFR-Installer" starts automatically when you insert the DVD-ROM. If this does not occur, please start the file „SFR-Installer.exe" which is in the main folder on the DVD-ROM.

To install the Sound-Teacher, click on the „SFR-1 Sound-Teacher" button and follow the further instructions on the screen.



Starting the Sound-Teacher

During the installation of the Sound-Teacher an entry is added to the start menu, which can be used to start the program. Click on the "Start" button at the bottom left-hand corner of the screen then on "Programs", on to "SFR-1 Sound-Teacher" and finally click on "SFR-1 Sound-Teacher". The program should now start.

If you chose to place an icon on the desktop during the installation procedure you can start the program by double-clicking on that icon.

When the program starts, it automatically opens the project on which you last worked.

Brief instructions for loading new sounds onto SD-card

Please follow the instructions below, for transferring a new sound onto SD card:

1. Insert the SD card into a cardreader, which is connected to the PC.
2. Start the SFR-1 Sound-Teacher.
3. Chose the SD card in the menu "**SD card**".
4. Klick in the menu "**File**" on "**Open project**".
5. Now select the desired sound project (.sfr file) e.g. from the "SFR-1 Sounds" folder on the DVD-ROM, and click on the button "**Open**".
6. If required, the configuration of the project can be changed.
7. Press the button "**Save project data onto SD card**".

Using software „SFR-1 Sound-Teacher“

Menue

File	Create new project	Creates a new project
	Open project	Opens an existing project
	Save project	Saves the current project
	Save project as	Saves a copy of the current project with a new name
	Print function assignment of the project	Prints an overview of the function assignments of all inputs and outputs
	Upload project data via datacable	Uploads the complete project data via datacable to the sound module
	Check automatically for updates	On every start of the Sound-Teacher, it will be checked if a new version is available
	Check now manually for updates	Checks if a new version is available
	Download sounds from the internet	Downloads new sounds from the internet
	Open Sound-Center	Opens the BEIER-Electronic Sound-Center, a sound data base from our cutomers
SD card	Diagnosis via SD card	Shows saved diagnostic data of the SFR-1 stored on the SD card
	Formating SD card	Formates (erases) the SD card
	D: to Z:	Choses the SD card
Data cable	Transfer speed	Change of data transmission speed
	Upload project data with data cable	Transfer of project data to SD card by data cable
	Diagnosis via datacable	Shows live diagnostic data of the SFR-1 with the datacable
	Control SFR-1 functions with data cable	Functions can be triggered with the data cyble without radio
Language	German	Switches to German language
	English	Switches to English language
	French	Switches to French language
Help	Operating manual	Opens this manual (PDF)
	Forum: SFR-1 Support	Opens the BEIER-Electronic forum at: SFR-1
	Forum: FAQ	Opens the BEIER-Electronic Forum at: FAQ
	Facebook	Opens the Facebook page from BEIER-Electronic
	Sound-Simulation	You can check e. g. the drive sound with the sound simulation without uploading data into the sound module
	Info	Shows informations about the software

Configuring sounds

A lot of different sounds can be saved in the sound slots of the SFR-1. The sounds are divided into five different ranges:

- Engine sound
- Engine sound 2
- Additional sounds
- Random sounds
- WAV-Player

Click with the mouse on the corresponding tab to configure a sound.

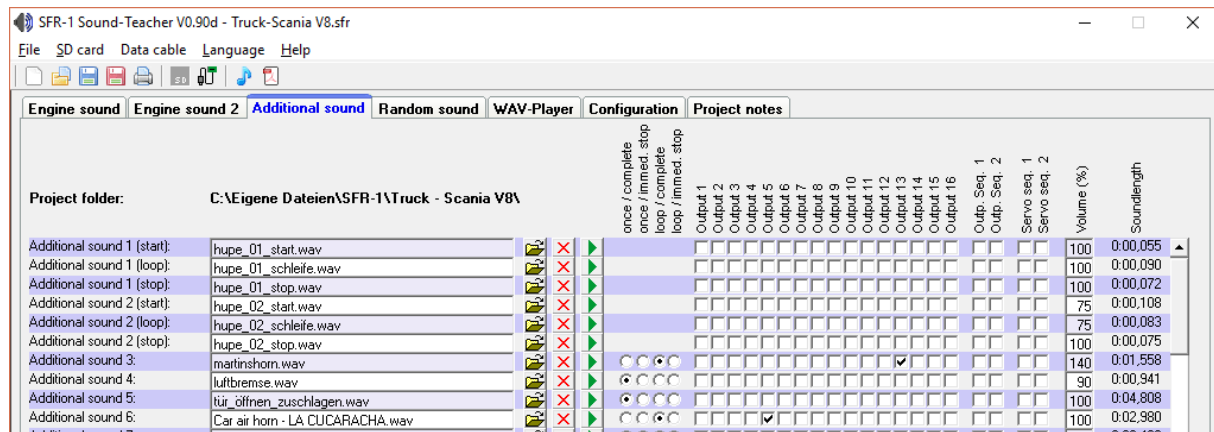

Project folder	Indicates the folder where the sound project is to be saved.
Slot name	Indicates the name of this slot, i.e. what sort of sound can be saved here (e.g. engine start sound).
File	File name of the WAV file which is saved in this slot.
	This button is used to load a new sound file into the slot.
	Erases the file from the slot.
	Plays back the file via the PC's integral loudspeaker.
Playback mode	At this point you can select the different play-back modes
Outputs/Sequences	Determines which outputs or output sequences are used when particular sounds are played back.
Volume	The volume of every sound can be changed here.
Soundlength	Shows length of the sound.

Opening of sound files

The folder „Sounds“ on the DVD contains general examples of soundfiles.

The folder „SFR-1 Sounds“ contains drive sounds for a lot of different vehicles.

With a click on the button, the Windows “file open dialog” opens, in which you can select the wanted sound file on your hard disk.

All WAV-files with following properties can be opened:

- 22,050 kHz or 44,100 kHz
- 8 Bit or 16 Bit
- Mono or Stereo

The Sound-Teacher always converts the soundfile into the format 44,1 kHz, 16 Bit, mono. To get a good sound, the WAV file should be in this format.

If you want to open a file, which is not in the required format, a message appears. If you still want to use this file, you must convert it first using a suitable program (e.g. Audacity).

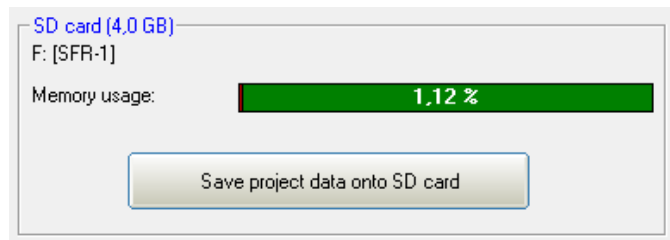

Memory usage indicates how much memory on the SD card is in use by the current project.

After finishing the selection of sounds and configurations, we recommend to save the complete project (**File** → **Save project**) on your hard drive. All settings of the sound slots and the complete configurations of the module are stored into one project file (*.sfr).

Therefore the Sound-Teacher asks, when you are saving a project, to copy all files to the project directory.

Configuring the sound module

Click on the “**configuration**“ tab in order to carry out adjustments to the SFR-1.

The settings are divided up into different ranges:

- General
- Speed Controller
- Engine sound
- Random sound
- S-BUS / i-BUS / SUMD
- Proportional channels
- Nautic / multiswitch
- EKMFA mode
- Outputs
- Servo outputs
- Function sequences
- Light module

If you change a value in your configuration, the project files must be transferred directly or via datacable to your SD card!

While saving a project, the sound settings of the slots and the configuration of the SFR-1 are stored together in the project file.

Configuration - General

SFR-1 Configuration

For steering proportional channel #2 can be used. Otherwise channel #2 can be used as normal proportional channel to control functions.

If digital servos are connected to the servo outputs, the speed of the pulse output on the servo outputs can be reduced from the standard 20 ms to 10 ms. Some digital servos work better with 10 ms than with 20 ms.

For troubleshooting while the module is running, the diagnostic data (data the soundmodule gets from the receiver) can be saved on SD card. This data can be read out and displayed in the Sound-Teacher (see 96).

Hint:

More comfortable is the live diagnosis function with the data cable K-USB-2.

Warning!
Only use this diagnosis function for troubleshooting and switch it off afterwards!
If the diagnosis function is activated, the sound playback may be faulty.

If EasyBus lighting boards from Kraftwerk are to be controlled by the SFR-1, this must be activated here. Further information, see page 51.

The current monitoring of the outputs can be deactivated. This can be necessary if interference pulses (mostly caused by the motor) influence the current measurement and thus lead to false overcurrent messages. Attention: If the current monitoring is deactivated, there is no longer any overload protection of the outputs!

The "Startup function" is always started when the module is switched on (supply voltage applied).

Volume

You can also configure the basic volume (10-100%) of the module here. This function is helpful if you don't use a volume control potentiometer. The volume can also be adjusted e.g. with a proportional channel configured with the functions "Volume +" and "Volume -".

The value for the reduced engine sound volume (see page 19) can be specified here.

Another option to change the volume with the transmitter is the "Direct volume control". One of the four proportional channels can be used for a stepless volume setting. You need a free slide or rotary control at your transmitter for that. However, this proportional channel can only be used for adjusting the volume and not for any other functions anymore!

To get a more realistic driving sound, a dynamic engine sound volume adjustment can be activated. The volume of the engine sound gets louder depending on the acceleration and speed. So whenever the engine needs more power. In standing position the volume is automatically by this percentage less! Therefore, we recommend selecting a low value at this setting.

Battery voltage monitoring

The type of battery used can be selected here. The thresholds for "charge battery" and "undervoltage" are adjusted for each battery type. If your battery type is not included, both values can also be set manually.

If the battery voltage is permanently below the respective threshold, the warning message is repeated over and over again within an adjustable time (10 - 250 s).

The corresponding warning sounds must be stored in the Sound-Teacher under "Additional sounds" (at the bottom). You will find sound templates on the DVD.

In addition, you can choose whether the sound output and / or the switching outputs should also be switched off in the event of undervoltage. The warning sound "Sound at undervoltage" is still played.

Multi function

Up to 3 functions can be assigned to each of the 4 multi functions. Using the multi function 3 functions can be activated at the same time, using only one position at the transmitter.

For instance: You would like to activate a searchlight and at the same time a servo sequence should be activated as well. This servo sequence controls a servo, which moves the searchlight. Without the multi function you would need 2 functions, triggered at the transmitter:

- a. Output x on
- b. Servo sequence x on

Using the multi function you can activate at the same time both, the output and the servo sequence by triggering only one function at the transmitter.

WAV-Player

The WAV-Player setting can be configured here. You can choose whether the next track should start automatically after finishing the previous track or the playback should stop.

Bluetooth controller:

If you want to control the SFR-1 via the Android app "[SFR-1 Controller](#)" with the Bluetooth module [BTC-1](#), this must be activated here. A 4-digit PIN protects the model from being controlled by others. Only if the same PIN is set in the app, the SFR-1 can be controlled with it. The default PIN is: 0000

Light module:

The protocol for the transmission to a light module in the trailer can be specified here. There are 3 variants to choose from:

- Infrared protocol for the light modules [SM-IR-16-2](#) and [LM-IR-16-4](#). This protocol works for both light modules, but is a bit slower in terms of transmission speed (latency max. 140 ms).
- Infrared protocol for the light module [LM-IR-16-4](#). This protocol does not work with the light module [SM-IR-16-2](#). But it is faster (latency max. 80 ms).
- Bluetooth protocol for the light module [LM-BT-16-4](#). This is the fastest protocol (latency max. 40 ms), but does not work with IR light modules.

Configuration – Speed Controller

The screenshot shows the configuration software interface for the SFR-1. The 'Configuration' tab is selected, and the 'Speed controller' sub-tab is active. The interface is divided into several sections:

- Speed controller properties:**
 - Speed controller with cruise control
 - Cruise control active only when driving forward
 - Speed controller with braking function
 - Emergency stop possible
 - Bell-armature motor (PWM 40 kHz)
- Channel reversion:**
 - Inverting motor
 - Invert steering channel (x2/2)
 - Invert servo channel (x5/L)
- Load regulation:**
 - Load regulation off
 - Load regulation light
 - Load regulation medium
 - Load regulation heavy
- Inertia:**
 - Inertia off
 - Inertia light
 - Inertia medium
 - Inertia heavy
- Steering:**
 - Inertia of steering off
 - Inertia of steering light
 - Inertia of steering medium
 - Inertia of steering heavy
 - Speed-dependent steering
 - Interval steering while standing
 - Steering angle limit at stationary: 100 %
 - Steering angle limit at top speed: 100 %
- Hand brake:**
 - Hand brake off
 - Hand brake soft
 - Hand brake medium
 - Hand brake hard
 - Handbrake only on while standing
- Throttle curve:** A graph showing a linear relationship between throttle position and speed. The x-axis is labeled 'backward' and 'forward'. Below the graph is a scale from 100 to 100 with a 'Reset' button.

Speed controller properties

Cruise control:

With activated cruise control the throttle position controls not any longer the actual driving speed but the change in speed. In neutral position (throttle stick) the cruise control keeps the speed.

The cruise control can be deactivated with the function „Cruise control on/off“ via a proportional channel or nautic/multiswitch.

The speed increases when pressing up the throttle stick and decreases (until standing) when pressing down.

While driving backwards the handling is the same (just opposite). The model accelerates when the throttle stick is put down and slows down when it is put up.

The further the throttle stick is moved away from neutral, the stronger the speed controller accelerates or decelerates.

The cruise control can be deactivated while driving backwards.

Brake function:

With the brake function the vehicle can be slowed down by the SFR-1.

The stronger the throttle stick is pressed down, the stronger the vehicle brakes.

To drive backwards the driving direction must be changes with function „Change of direction“. To accelerate backwards (in reverse gear) the throttle stick must be pressed up/forwards.

Driving modes

There are 4 driving modes, combining the functions cruise control and braking. Depending on the driving mode the throttle channel is used differently:

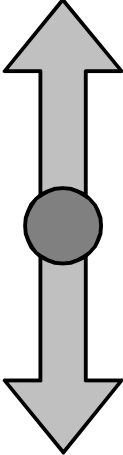
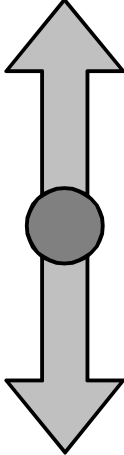
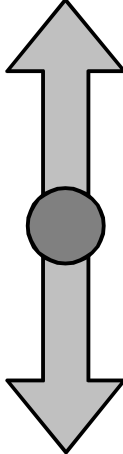
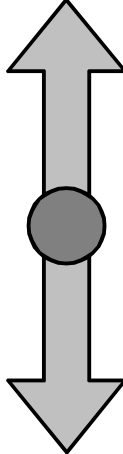
No cruise control No brake function	No cruise control with brake	with cruise control no brake function	with cruise control with brake
driving forwards  driving backwards	driving forwards and backwards  braking	forwards accelerating / backwards slowing down  forwards slowing down / backwards accelerating	forwards and backwards accelerating  slowing down and braking

With activated braking function the driving direction must be changed with the function „Change of direction“.

For driving backwards it is not always practical using the cruise control. Therefore, it is possible to turn off the cruise control automatically while driving backward. By selecting the option the cruise control is only active while driving forwards.

Emergency stop:

With the function „Emergency stop possible“, the model can quickly be stopped by a complete pressing down of the gas throttle. Other settings, such as cruise control, brake funktion, load regulation, hand brake, inertia etc. have no effect on this function. The emergency stop is always given priority.

Bell armature motor:

With a bell armature motor the PWM frequency is increased to motor gently 40 kHz.

Channel reversion

In case the motor is running in the opposite direction (backwards instead of forwards) it can be inverted here.

The steering channel (X2/2) and the steering servo (X5/L) can be inverted (reversed). The setting swaps right and left.

Load regulation

With activated load regulation one of the different regulation intensities (light, medium and heavy) can be set here.

Inertia

To simulate a very heavy vehicle the option mass inertia can be activated here. Acceleration and deceleration are slowed down for a realistic driving behaviour. Keep in mind: the vehicle also has a longer stopping distance!

With a proportional channel or a nautic/multiswitch and the function “ Inertia light, medium, heavy and off“ different intensities of inertia can be set while driving.

Inertia of steering

For a realistic steering behaviour a inertia can be activated. For this effect the steering servo must be connected to proportional channel X4/2.

There is also an option for a speed dependent steering inertia:

- While parking: high inertia
- Slow driving: low inertia
- Medium drive: medium inertia
- Fast drive: high inertia

With the parameters „Steering angle limit at stationary“ and „Steering angle limit at top speed“ the steering angle can be optimized. Values between 30 % and 120 % can be set. The smaller the value, the smaller the steering angle. Values higher than 100 % make the steering angle larger. It is important to check first, if the steering servo is suitable for large angles.

When driving between stationary and full throttle the SFR-1 calculates the corresponding steering angle within the defined max/min values.

If no limits are manually set, the standard values are 100 %.

Optionally, an interval steering can be activated while standing. As a result, the steering operation is not performed in one turn at greater steering movements in standing, but the movement of the steering servo repeatedly interrupted briefly. This is intended to simulate displace hands on the steering wheel with stiff steering systems.

The application of steering angle limitation is quite useful, in case there is no option to limit the angle directly at the radio.

Furthermore this function enables to use a different range of steering for manoeuvring and for normal (fast) driving. During manoeuvring the full range is useful whereas at high speed a smaller steering range enables a more sensitive steering.

Hardness of handbrake

If the function handbrake is activated with DIP switch 4 the hardness of braking can be set here.

The handbrake can be active only while parking/standing. Without this option, the handbrake hits as soon as the throttle is in neutral position and the vehicle is still rolling.

Throttle curve 1 and 2

Using the curve, the proportion between throttle signal and driving behaviour can be set in the diagram. Both driving directions (backwards and forwards) have 10 values (at 10 %, 20 %, 30 %, 40 %, 50 %, 60 %, 70 %, 80 %, 90 % and 100 % of throttle signal) to adjust the driving behaviour.

For example a very sensitive acceleration behaviour for driving slowly or a limited maximum speed can be set.

With „reset“ the curve returns to its initial values.

The throttle curve 2 can be activated with a function while driving. This enables for example to use throttle curve 1 for normal driving and throttle curve 2 for manoeuvring with very sensitive acceleration behaviour.

Example for normal driving:

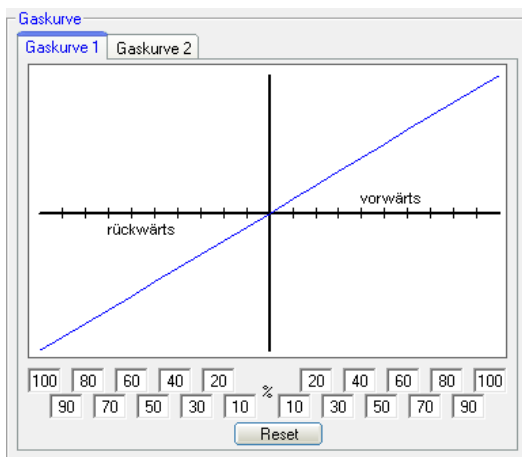

Example for manoeuvring:

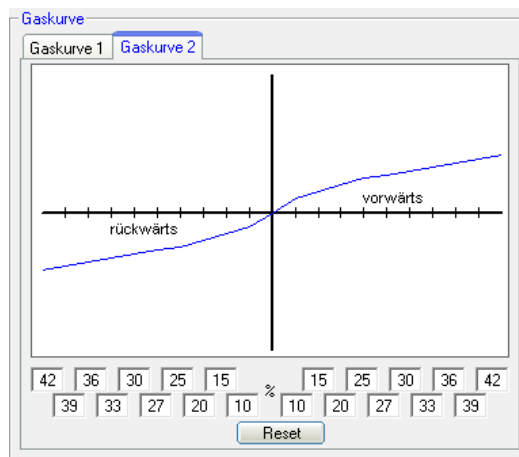

Configuration – Engine Sound – Engine Sound

The screenshot shows the 'Configuration' window for 'Engine sound'. The 'Engine sound options' section includes:

- Threshold for slow down: 4
- Threshold for speed up: 4
- Fast switching
- Threshold for brake noise: 15
- Threshold cornering squeak: 70
- Turn warning sound up to speed: 100%
- Turn on engine sound automatically by motion. And turn off after 10 sec. in stationary.
- Driving is only possible when the engine sound is on.
- Time for warmstart: 20
- Rpm change when triggering function: -30%
- Engine sound rpm change: -30%

The 'Speed steps / gears' section includes:

- Gears forward: 3
- Gears backward: 1
- Zero point deadband: 5
- Stationary/motion/gear hysteresis: 5
- Play change sound parallel to engine sound
- Skip gearshift/downshift at stopping

The graph on the right shows the engine sound level (Y-axis, 60% to 300%) across different gears (FG1, FG2, FG3) for both backward and forward directions. The sound level is 100% at 0 RPM and increases to 200% at 300% RPM for each gear. The graph shows a blue line for forward gears and a red line for backward gears.

Engine sound options

Thresholds for slow down and speed up:

These thresholds set how strong the speed must be changed so that the normal driving sound is changed to deceleration or acceleration. Values between 1 and 30 are possible. The higher the threshold is set, the more it has to be decelerated or accelerated so that the sound is switched.

If you activate “fast switching”, the module immediately switches when the speed changes. This is particularly useful for long sounds in the driving sound slots. If the module is required to simulate a slow-revving engine (e.g. single-cylinder motor), fast switching should be deactivated. In this case vehicle starting and stopping sounds are not played, as well.

Brake noise:

The brake sound threshold determines how strongly the vehicle must be decelerated before the brake sound is played. Values between 1 and 30 are possible. The higher the threshold, the stronger the deceleration must be in order to activate the brake noise.

Cornering squeak:

As soon as the vehicle is turning, the cornering squeak is played. The higher the value is, the more the steering must be to trigger the cornering squeak. Values between 20 and 127 are possible.

The threshold for the turn warning sound determines up to which driving speed, the turn warning sound should be played.

Automatic driving sound activation:

As an option you can select an automatic driving sound activation (see page 23). The engine sound always switches on automatically, as soon as you move the throttle stick shortly while standing. After an adjustable time the engine sound turns off automatically.

Driving is only possible when the engine sound is on:

If this option is activated, the model can only be driven if the engine sound has been switched on before.

Time for warmstart:

If both sounds "Engine coldstart sound" and "Engine warmstart sound" are used, the time can be specified which determines how long the driving sound had to be turned off in order to play the coldstart sound instead of the warmstart sound after a new start.

Speed change when triggering function "Engine sound rpm change":

Here you can setup the change of the rpm for idle or driving sound between a range of -50% and +50%. Minus values make the sound slower and positive values faster. With this setting you change the speed of the actual sound (idle or driving sound). It initiates no change between idle and driving sound. This function is quite useful for example if you want to change the speed of a hydraulic pump of a construction machine.

Speed steps/gears

Gears forward/backward:

Here you can choose how many different driving sounds or gears, the engine sound should have.

When option "Play change sound parallel to engine sound" is activated, the driving sound changes immediately from the old to the new engine sound and the change sound is played simultaneously during this change. If this option is not activated, the old engine sound stops, the change-sound is played and after that the new engine sound starts.

As an additional option, it is possible to skip gearshift and downshift at stopping. If this option is activated, the engine sound will directly jump to FG1 when you stop the model.

Zero point deadband threshold:

When the vehicle is standing, i.e. the drive motors are not running, but the sound module is not generating the idle sound. If it occasionally plays the driving sound instead, then this value should be raised slightly. Values between 2 and 30 are possible.

On the other hand, if the idle sound continues to play even though the vehicle is no longer stationary, then this value can be reduced slightly.

Stationary/motion/gear hysteresis:

When the vehicle is moving very slowly and the sound constantly alternates between idle and running sound, then this value should be raised slightly.

Also if the engine sound alternates steadily between two speed steps/gears while driving, this value should be raised slightly, as well. Values between 1 and 10 are possible.

Driving sound diagram:

The diagram shows graphically which driving sound/gear is played at the corresponding speed. In addition it is possible to set the driving sound directly in the diagram (see page 93).

Configuration - Engine Sound - Engine Sound 2



Different parameters for engine sound 2 can be configured in this section.

Speed via proportional channels:

Here it is determined by which proportional channel the speed of the 2nd engine sound is to be controlled.

Zero point:

The neutral position of the throttle stick can be set between 1.00 - 2.00 ms. Most transmitter and speed controller have its zero point at 1.50 ms.

Zero point deadband:

For the throttle control an area can be defined with this deadband, where the stationary sound for engine sound 2 should be played. This area ranges between 1 and 30.

Maximum sound speed:

The sound speed at full power can be set between 60% and 300%.

Activate the option "When starting engine sound 1 or 2, turn off the other", when you never want to use both engine sounds at the same time. If you are running your model with engine sound 1 and you activate engine sound 2, the first engine sound is automatically turned off. If the first engine sound is activated again, the second engine sound goes off automatically.

Additionally you can choose whether changing sounds between the two engine sounds, like starting and stopping sounds should be played.

With the option "Turn on engine sound automatically by motion" it can be determined, that the second driving sound automatically turns on as soon as the throttle control for the engine sound 2 is out of neutral position. This is useful, for example, if you want to realize a tank turret rotation. Otherwise, you need to activate engine sound 2 first with the function "Engine sound 2 on/off".

Configuration - Random sounds

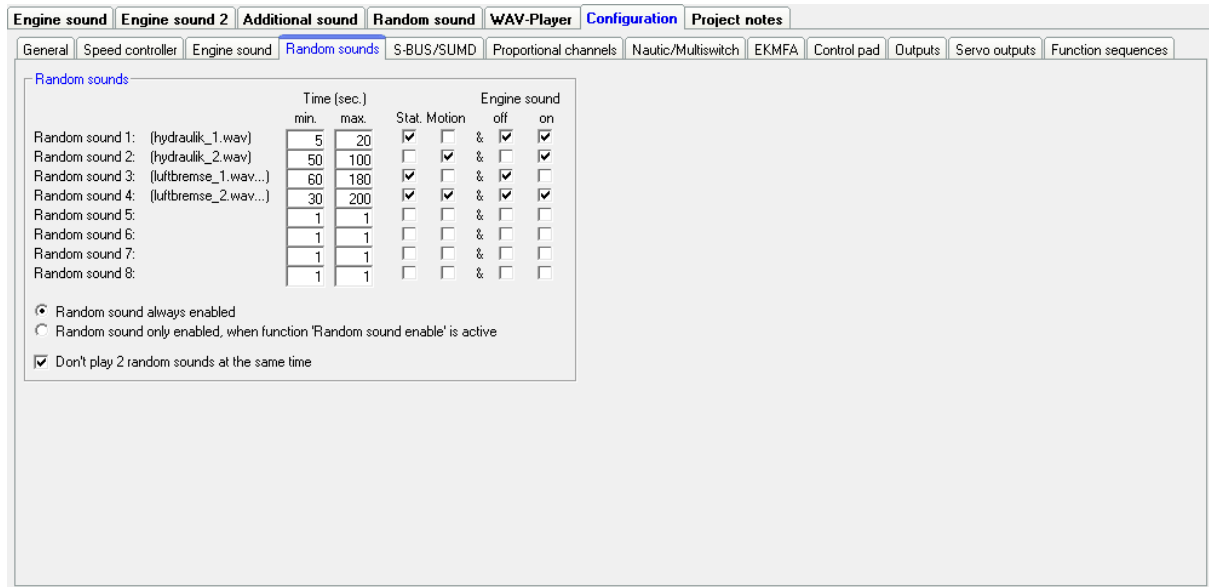

Random sounds

If you want to play random sounds (see page 30), you can set the time in which interval a random sounds should be triggered. The time ranges between 1 and 999 seconds.

With the checkboxes it is also possible to define conditions when random sounds should be activated, i.e. whether the random sounds are played only when the model is stationary and / or moving, or whether the engine sound must be on and / or off.

If a random sound should be played, at least one checkbox at each side of the „&“ symbol must be activated.

You can also select whether random sounds generally should be played or only when the function "Random sound enable" is activated, for example by a proportional channel.

If the option "Don't play 2 random sounds at the same time" is activated, only one random sound can be played, otherwise 2 or more random sound could be played simultaneously.

Configuration - S-BUS / SUMD

Engine sound		Engine sound 2		Additional sound		Random sound		WAV-Player		Configuration		Project notes																																																																																																																																					
General		Speed controller		Engine sound		Random sounds		S-BUS/SUMD		Proportional channels		Nautic/Multiswitch																																																																																																																																					
										EKMFA		Control pad																																																																																																																																					
												Outputs																																																																																																																																					
												Servo outputs																																																																																																																																					
												Function sequences																																																																																																																																					
S-BUS / SUMD																																																																																																																																																	
<input type="checkbox"/> Activate S-BUS at X2/6 <input checked="" type="checkbox"/> Activate SUMD at X2/6 <input type="checkbox"/> i-BUS auf X2/6 aktivieren																																																																																																																																																	
Prop #1: S-BUS / SUMD Ch. 3 Prop #2: S-BUS / SUMD Ch. 2 Prop #3: S-BUS / SUMD Ch. 1 Prop #4: S-BUS / SUMD Ch. 4 Prop #5: S-BUS / SUMD Ch. 7 Prop #6: S-BUS / SUMD Ch. 8 Prop #7: - Prop #8: - Prop #9: - Prop #10: S-BUS / SUMD Ch. 14 Prop #11: S-BUS / SUMD Ch. 15 Prop #12: S-BUS / SUMD Ch. 16 Prop #13: - Prop #14: - Prop #15: - Prop #16: -																																																																																																																																																	
<input type="button" value="Reset"/>																																																																																																																																																	
Digital switches (only for Graupner SUMD3)																																																																																																																																																	
<table border="0" style="width: 100%;"> <tr> <td style="width: 25%;">DS 1:</td> <td style="width: 25%;">Engine sound on/off</td> <td style="width: 25%;">DS 23:</td> <td style="width: 25%;">-</td> <td style="width: 25%;">DS 45:</td> <td style="width: 25%;">-</td> </tr> <tr> <td>DS 2:</td> <td>Volume +</td> <td>DS 24:</td> <td>-</td> <td>DS 46:</td> <td>-</td> </tr> <tr> <td>DS 3:</td> <td>Volume -</td> <td>DS 25:</td> <td>Additional sound 1 (hupe_01_schl)</td> <td>DS 47:</td> <td>-</td> </tr> <tr> <td>DS 4:</td> <td>Parking light</td> <td>DS 26:</td> <td>Additional sound 2 (hupe_02_schl)</td> <td>DS 48:</td> <td>-</td> </tr> <tr> <td>DS 5:</td> <td>Low beam headlight</td> <td>DS 27:</td> <td>Additional sound 3 (martinshorn.wav)</td> <td>DS 49:</td> <td>WAV-Player: Play/Stop</td> </tr> <tr> <td>DS 6:</td> <td>High beam headlight</td> <td>DS 28:</td> <td>Additional sound 6 (Car air horn - L)</td> <td>DS 50:</td> <td>WAV-Player: Pause</td> </tr> <tr> <td>DS 7:</td> <td>Front fog light</td> <td>DS 29:</td> <td>Additional sound 7 (hupe_04.wav)</td> <td>DS 51:</td> <td>WAV-Player: Track rev</td> </tr> <tr> <td>DS 8:</td> <td>Rear fog light</td> <td>DS 30:</td> <td>Additional sound 8 (hupe_05.wav)</td> <td>DS 52:</td> <td>WAV-Player: Track fwd</td> </tr> <tr> <td>DS 9:</td> <td>Indicator left</td> <td>DS 31:</td> <td>-</td> <td>DS 53:</td> <td>WAV-Player: Random</td> </tr> <tr> <td>DS 10:</td> <td>Indicator right</td> <td>DS 32:</td> <td>-</td> <td>DS 54:</td> <td>-</td> </tr> <tr> <td>DS 11:</td> <td>Hazard lights</td> <td>DS 33:</td> <td>Output sequence 1</td> <td>DS 55:</td> <td>-</td> </tr> <tr> <td>DS 12:</td> <td>Output 8 (Innenbeleuchtung)</td> <td>DS 34:</td> <td>Output sequence 2</td> <td>DS 56:</td> <td>Servo 1 Position 1</td> </tr> <tr> <td>DS 13:</td> <td>Output 14 (Rundumleuchte)</td> <td>DS 35:</td> <td>Output sequence 3</td> <td>DS 57:</td> <td>Servo 1 Position 2</td> </tr> <tr> <td>DS 14:</td> <td>-</td> <td>DS 36:</td> <td>Output sequence 4</td> <td>DS 58:</td> <td>Servo 2 Position 1</td> </tr> <tr> <td>DS 15:</td> <td>-</td> <td>DS 37:</td> <td>Function sequence 1</td> <td>DS 59:</td> <td>Servo 2 Position 2</td> </tr> <tr> <td>DS 16:</td> <td>-</td> <td>DS 38:</td> <td>Function sequence 2</td> <td>DS 60:</td> <td>-</td> </tr> <tr> <td>DS 17:</td> <td>Cruise control on/off</td> <td>DS 39:</td> <td>Multi function 1</td> <td>DS 61:</td> <td>-</td> </tr> <tr> <td>DS 18:</td> <td>Inertia medium</td> <td>DS 40:</td> <td>Multi function 2</td> <td>DS 62:</td> <td>-</td> </tr> <tr> <td>DS 19:</td> <td>Inertia off</td> <td>DS 41:</td> <td>-</td> <td>DS 63:</td> <td>-</td> </tr> <tr> <td>DS 20:</td> <td>Steering limit off</td> <td>DS 42:</td> <td>-</td> <td>DS 64:</td> <td>-</td> </tr> <tr> <td>DS 21:</td> <td>-</td> <td>DS 43:</td> <td>-</td> <td></td> <td></td> </tr> <tr> <td>DS 22:</td> <td>-</td> <td>DS 44:</td> <td>-</td> <td></td> <td></td> </tr> </table>														DS 1:	Engine sound on/off	DS 23:	-	DS 45:	-	DS 2:	Volume +	DS 24:	-	DS 46:	-	DS 3:	Volume -	DS 25:	Additional sound 1 (hupe_01_schl)	DS 47:	-	DS 4:	Parking light	DS 26:	Additional sound 2 (hupe_02_schl)	DS 48:	-	DS 5:	Low beam headlight	DS 27:	Additional sound 3 (martinshorn.wav)	DS 49:	WAV-Player: Play/Stop	DS 6:	High beam headlight	DS 28:	Additional sound 6 (Car air horn - L)	DS 50:	WAV-Player: Pause	DS 7:	Front fog light	DS 29:	Additional sound 7 (hupe_04.wav)	DS 51:	WAV-Player: Track rev	DS 8:	Rear fog light	DS 30:	Additional sound 8 (hupe_05.wav)	DS 52:	WAV-Player: Track fwd	DS 9:	Indicator left	DS 31:	-	DS 53:	WAV-Player: Random	DS 10:	Indicator right	DS 32:	-	DS 54:	-	DS 11:	Hazard lights	DS 33:	Output sequence 1	DS 55:	-	DS 12:	Output 8 (Innenbeleuchtung)	DS 34:	Output sequence 2	DS 56:	Servo 1 Position 1	DS 13:	Output 14 (Rundumleuchte)	DS 35:	Output sequence 3	DS 57:	Servo 1 Position 2	DS 14:	-	DS 36:	Output sequence 4	DS 58:	Servo 2 Position 1	DS 15:	-	DS 37:	Function sequence 1	DS 59:	Servo 2 Position 2	DS 16:	-	DS 38:	Function sequence 2	DS 60:	-	DS 17:	Cruise control on/off	DS 39:	Multi function 1	DS 61:	-	DS 18:	Inertia medium	DS 40:	Multi function 2	DS 62:	-	DS 19:	Inertia off	DS 41:	-	DS 63:	-	DS 20:	Steering limit off	DS 42:	-	DS 64:	-	DS 21:	-	DS 43:	-			DS 22:	-	DS 44:	-		
DS 1:	Engine sound on/off	DS 23:	-	DS 45:	-																																																																																																																																												
DS 2:	Volume +	DS 24:	-	DS 46:	-																																																																																																																																												
DS 3:	Volume -	DS 25:	Additional sound 1 (hupe_01_schl)	DS 47:	-																																																																																																																																												
DS 4:	Parking light	DS 26:	Additional sound 2 (hupe_02_schl)	DS 48:	-																																																																																																																																												
DS 5:	Low beam headlight	DS 27:	Additional sound 3 (martinshorn.wav)	DS 49:	WAV-Player: Play/Stop																																																																																																																																												
DS 6:	High beam headlight	DS 28:	Additional sound 6 (Car air horn - L)	DS 50:	WAV-Player: Pause																																																																																																																																												
DS 7:	Front fog light	DS 29:	Additional sound 7 (hupe_04.wav)	DS 51:	WAV-Player: Track rev																																																																																																																																												
DS 8:	Rear fog light	DS 30:	Additional sound 8 (hupe_05.wav)	DS 52:	WAV-Player: Track fwd																																																																																																																																												
DS 9:	Indicator left	DS 31:	-	DS 53:	WAV-Player: Random																																																																																																																																												
DS 10:	Indicator right	DS 32:	-	DS 54:	-																																																																																																																																												
DS 11:	Hazard lights	DS 33:	Output sequence 1	DS 55:	-																																																																																																																																												
DS 12:	Output 8 (Innenbeleuchtung)	DS 34:	Output sequence 2	DS 56:	Servo 1 Position 1																																																																																																																																												
DS 13:	Output 14 (Rundumleuchte)	DS 35:	Output sequence 3	DS 57:	Servo 1 Position 2																																																																																																																																												
DS 14:	-	DS 36:	Output sequence 4	DS 58:	Servo 2 Position 1																																																																																																																																												
DS 15:	-	DS 37:	Function sequence 1	DS 59:	Servo 2 Position 2																																																																																																																																												
DS 16:	-	DS 38:	Function sequence 2	DS 60:	-																																																																																																																																												
DS 17:	Cruise control on/off	DS 39:	Multi function 1	DS 61:	-																																																																																																																																												
DS 18:	Inertia medium	DS 40:	Multi function 2	DS 62:	-																																																																																																																																												
DS 19:	Inertia off	DS 41:	-	DS 63:	-																																																																																																																																												
DS 20:	Steering limit off	DS 42:	-	DS 64:	-																																																																																																																																												
DS 21:	-	DS 43:	-																																																																																																																																														
DS 22:	-	DS 44:	-																																																																																																																																														
<input type="button" value="Delete assignments"/>																																																																																																																																																	

S-BUS / SUMD

If sum signals should be used, they must be activated here. The sum signal channel of the receiver is connected to proportional channel #6 (X2/6) of the SFR-1. The proportional channels of the SFR-1 can be assigned to the sum signal channels (see also page 36).

Configuration - S-BUS / SUMD - Digital switches (only for Graupner SUMD3)

The 64 digital switches of the sum signal SUMD3, the desired functions can be assigned here. Please follow the instructions on page 37.

Configuration - Proportional channels

Assignments and thresholds for proportional channel

For each of the proportional channels # 2 - # 6 (or # 2 - # 16 when using a sum signal), areas A, B, C and D can be assigned with the possible functions of the sound module.

The left picture shows five ranges of a channel. You can define the thresholds for each range manually (see page 32) by moving the blue sliders up and down. The number on top shows the value of each threshold.

The reset button restores the threshold standard values.

Channel reversion

The directions of the proportional channels can also be inverted. If channel #2 is used for steering, it is not possible to assign functions or to invert it.

Activation delay

Certain times can be set that determine how long the joystick or switch must be in the positions A/D and B/C in order to activate the corresponding functions. Times between 10 and 2500 ms are possible.

However, the values defined here are always valid for all proportional channels. It is not possible to define delays for one channel separately.

The reset button will restore standard values.

Configuration - Nautic/Multiswitch

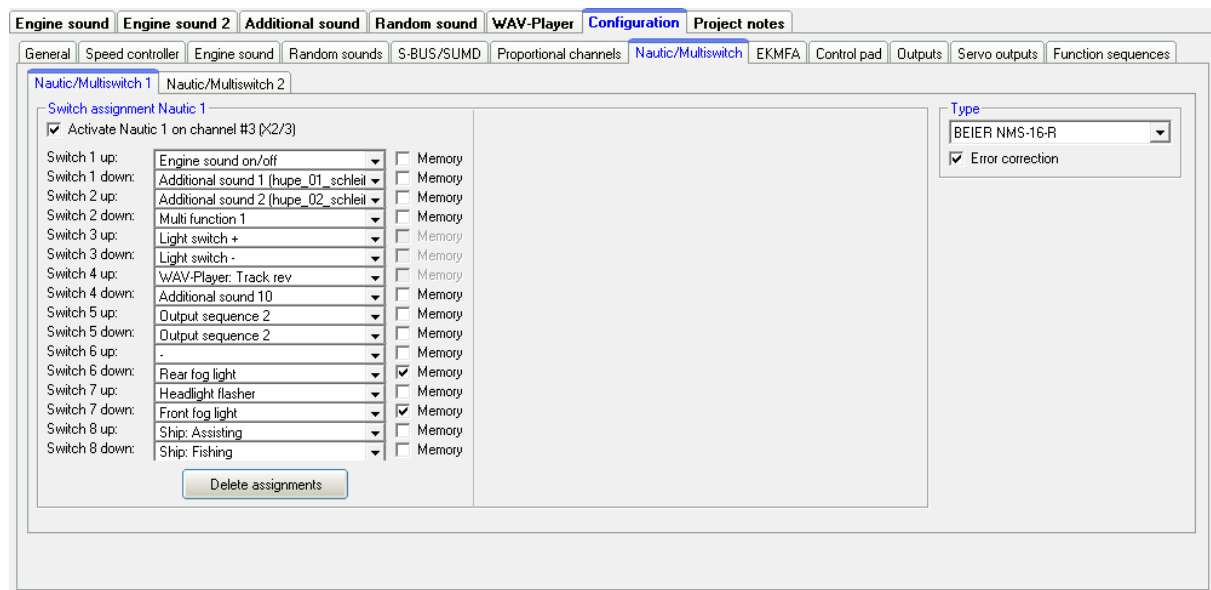

If you want to use the nautic mode 1 or 2, you will first have to activate it here and connect the SFR-1 prop. channel #3 (X2/3) or #4(X2/4) to the receiver channel.

Switch assignment

Every switch position can be assigned to a function (see page 25).

Depending on the function, a memory setting for the corresponding switch can be activated.

Type

Select the type of your radio control system and your nautic switch module here.

Error correction

If problems occur in receiving the nautic signal, you can activate error correction, as this may lead to a more reliable transmission of the nautic switch data. However, activating error correction slows down the transmission slightly (approx. +200 ms). Especially with some 2.4 GHz transmitters it is advisable to switch error correction on, as under certain circumstances incorrect switch positions are occasionally transmitted, and this could trigger undesired actions.

Manual settings

Opting for manual settings enables you to set values for the transmission protocol of the nautic mode manually. These values should only be altered as instructed. Normally it is not necessary to set the values manually.

Configuration - EKMFA

The screenshot shows the 'Configuration' tab for EKMFA mode. It features a top navigation bar with tabs: Engine sound, Engine sound 2, Additional sound, Random sound, WAV-Player, Configuration (selected), and Project notes. Below this is a sub-navigation bar with tabs: General, Speed controller, Engine sound, Random sounds, S-BUS/SUMD, Proportional channels, Nautic/Multiswitch, EKMFA (selected), Control pad, Outputs, Servo outputs, and Function sequences.

The main configuration area is titled 'Assignment EKMFA' and includes a checkbox 'Activate EKMFA on channel #3 (2/3)'. It contains two columns of dropdown menus for assigning functions to 15 positions in A and D. A 'Delete assignments' button is located at the bottom left of the assignment area.

On the right, the 'Activation delay (ms)' section has two input fields: 'Position A/D:' set to 1000 and 'Position B/C:' set to 500, with a 'Reset' button.

Position	Assignment
1 x in position A:	Additional sound 1 (hupe_01_schleil)
2 x in position A:	Additional sound 2 (hupe_02_schleil)
3 x in position A:	Additional sound 3 (martinshorn.wav)
4 x in position A:	Additional sound 4 (luftbremse.wav)
5 x in position A:	Additional sound 5 (tuir_oeffnen_zusc)
6 x in position A:	Additional sound 6 (Car air horn - LA)
7 x in position A:	Additional sound 7 (hupe_04.wav)
8 x in position A:	Additional sound 8 (hupe_05.wav)
9 x in position A:	Additional sound 9
10 x in position A:	Additional sound 10
11 x in position A:	Additional sound 11
12 x in position A:	-
13 x in position A:	-
14 x in position A:	-
15 x in position A:	-
1 x in position D:	Ship: Towing
2 x in position D:	Light switch -
3 x in position D:	Parking light
4 x in position D:	Low beam headlight
5 x in position D:	High beam headlight
6 x in position D:	-
7 x in position D:	Output 10
8 x in position D:	Output sequence 1
9 x in position D:	Volume +
10 x in position D:	WAV-Player: Play/Stop
11 x in position D:	Servo 1 Position 1
12 x in position D:	Servo 1 Position 2
13 x in position D:	Servo 2 Position 1
14 x in position D:	Servo 2 Position 4
15 x in position D:	-

If you want to use EMKFA mode, you have to activate it first.

The used functions for EKMFA mode (see page 36) can be configured here.

Of course, you don't have to assign every position (2 x 15 positions).

Activation delay

Certain times can be set that determine how long the joystick or switch must be in the positions A/D and B/C in order to activate the corresponding functions. Times between 10 and 2500ms are possible.

The reset button will restore the standard values.

Configuration – Control Panel

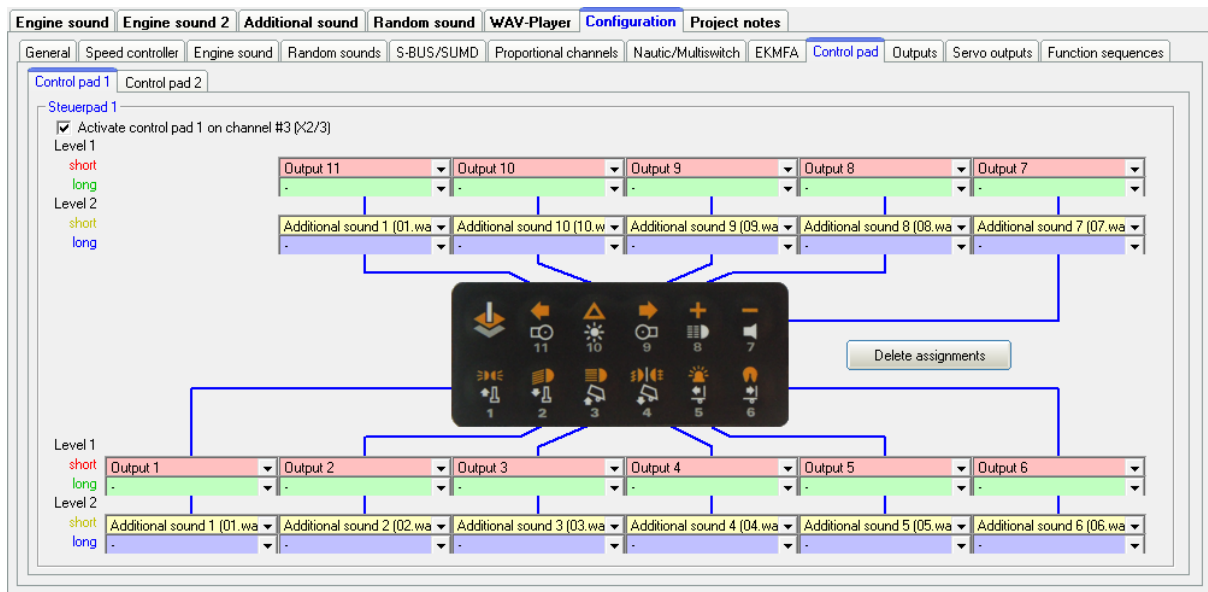

The SFR-1 can also evaluate the control pads [Light and Sound](#) from the company Kraftwerk. The control pad channel is connected from the receiver output to channel # 3 (X2 / 3) or channel # 4 (X2 / 4) of the SFR-1.

The control pad can trigger up to 44 functions:

- 11 keys on level 1, short key press
- 11 keys on level 1, long key press
- 11 keys on level 2, short key press
- 11 keys on level 2, long key press

All push buttons can be assigned on both levels, with the desired functions.

Switching from level 1 to level 2 is done by the leftmost button (shift) in the top row. Pressing this shift button switches to level 2. The next time you press one of the buttons 1 - 11, the assigned function will be triggered by level 2. At the same time, when the function is triggered, the level is automatically switched back to level 1 again.

If you switch to level 2 and then no button is pressed within 10 seconds, the pad also automatically returns to level 1 again.

Teach-in the control pad:

Before first use, the SFR-1 must be taught-in on the control pad and the transmitter. This works as follows:

1. Connect throttle channel, steering channel and all other proportional channels you want to use to your receiver.
2. All channels must be in neutral position. Turn on receiver and SFR-1.
3. Activate the setup, with the blue „Setup“ button on the SFR-1 board, until the green LED flashes fast. The blue LED flashes once.
4. Now briefly press the "Shift" key (top row, leftmost) on the control pad.
5. Then briefly press button No. 7 (top row, rightmost) on the control pad. The blue LED lights up now.
6. Now press the blue Setup button again until the green LED stops blinking.
7. The teach-in process is finished.

Afterwards it is recommended to check the evaluation of the buttons of the control pad in the diagnosis (see page 96). With Prop # 3 or Prop # 4, pressing the button will now also show the button numbers.

If the button numbers displayed in the diagnostics do not match the buttons pressed, you may need to change the "Transmit Power" of the control pad (see control pad manual). After adjusting the "Transmit power", the teach-in process must be repeated!

Configuration - Outputs

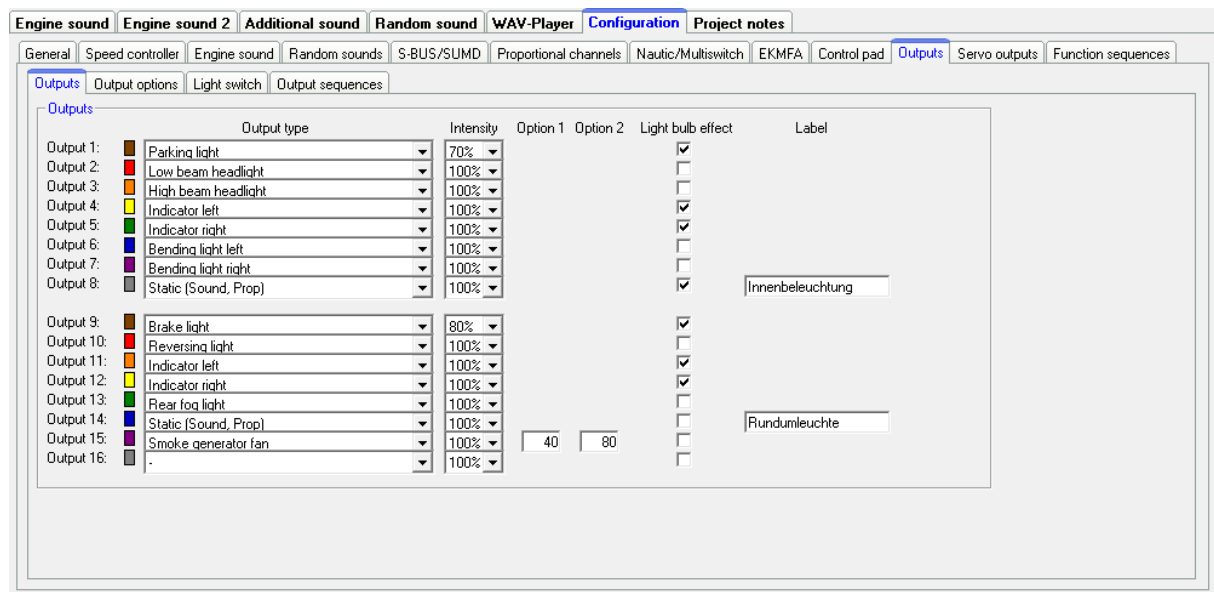

The colored small boxes next to each output indicate the color of the flat ribbon cable that is connected to each output at the SFR-1.

Output type

You can assign 16 switching-outputs to various output types/characteristics (see page 37).

Intensity

The intensity can be set in 2%-steps for every output.

Option 1 and option 2

For some output types different values can be set. For more details, see the description of outputs starting on page 37.

Light bulb effect

Optionally, a light bulb effect can be activated for each output. This behaves an LED when switching on and off, then like a light bulb (softer on and off).

Labeling

For certain output types (static, flashing, pulse and flickering) own labels can be given for the outputs. This makes it easier to "find" these outputs in the selection of functions.

Configuration - Outputs - Output options

The screenshot shows the 'Output options' configuration window. It is divided into several sections:

- Light flickering when starting:** Set to 'medium'.
- Light bulb effect:** Set to 'light'.
- Brake light settings:**
 - Brake light always on at stationary
 - Brake light remain on for: 5 seconds
 - Emergency brake light while heavy braking
 - Hazard warning lights automatically on after emergency brake light
- Thresholds:**
 - Threshold for brake light: 5
 - Threshold emergency brake light: 30
- Hazard lights:**
 - Hazard lights automatically on when reversing
 - Switch off indicator after 5 flashes
 - Automatic indicator lights while turning
 - American indicator mode
- Steering threshold indicator:**
 - Steering threshold indicator on: 40
 - Steering threshold indicator off: 10
- Flashfreq:**
 - on (x 10ms): 50
 - off (x 10ms): 50
- Other options:**
 - Bending lights also work when the light is off
 - Bending light via steering (Prop. channel #2)
 - Bending light via indicators
 - Bending lights on while driving backwards
 - Using bending light as fog light
 - Steering threshold bending light: 20
 - Daytime running light via light switch
 - Daytime running light is only switched on when engine sound is on
 - Reversing light and reversing warning only on when driving, not when stationary
 - Low beam with xenon HID turn-on effect
 - High beam with xenon HID turn-on effect
 - Parking light and low beam headlight always on when engine sound is on
 - Parking light and low beam headlight always on when engine sound 2 is on
 - Automatically 'in operation' / 'at anchor' at a ship: 10 s
 - Smoke generator always on, when engine sound is on
 - Smoke generator always on, when engine sound 2 is on
 - Trailing smoke generator fan: 0 s

If the function "Light flickering when starting" is activated, all 16 outputs will flicker while the starting noise (coldstart or warmstart) is played.

The light bulb effect can be set in 3 levels: Light, medium and strong.

Brake lights:

If the selection „Brake light always on at stationary“ is activated, the brake light is always turned on whenever the model is standing.

An adjustable afterglow of the brake light can also be activated.

If "Emergency brake while heavy braking" is activated the brake light flashes at a frequency of 3Hz during heavy braking. The duration for the flashing is defined in "Brake light remains on for: X seconds". If in addition the option "Hazard warning lights automatically on after emergency brake light" the hazard lights turn automatically on after heavy braking. The lights remain on, as long as they are switched off manually or the vehicle starts moving.

The brake light threshold determines how strong the vehicle must be decelerated before the brake light is activated. The higher the threshold, the stronger the deceleration must be in order to activate the brake light. Values between 1 and 30 are possible.

The emergency brake light threshold determines how strong the vehicle must be decelerated before the emergency brake light is activated. The higher the threshold, the stronger the deceleration must be in order to activate the emergency brake light. Values between 1 and 30 are possible.

Indicator lights:

If the selection „Hazard light automatically on when reversing“ is activated, the two indicator lights are on, once the model is reversing.

It can also be specified that indicators will turn off automatically after a certain number of flashes.

The indicators can be activated fully automatically as soon as the vehicle is steered and then deactivated again. The steering thresholds for this can be set or adapted separately. Allowed values are 5 - 100 (%) and correspond to the steering angle. The "Steering threshold indicator on" must be equal to or greater than "Steering threshold indicator off".

If the „American indicator mode“ is activated, the indicators always light when the parking light is on.

The indicator light threshold determines how strong the vehicle must turn until the indicator light is activated. The higher the threshold, the stronger the vehicle must turn in order to activate the indicator light.

The flashing rate for the indicators can be set, as well. The values for „on“ and „off“, multiplied by 10 ms, is the duration of the light and dark phases of the indicator.

Bending lights:

If the option "Bendings light also work when the light is off" is not selected, then either the parking light or the low beam headlight must be on for bending light to work.

With the option "Bending light via steering on prop. channel #2" the bending lights are automatically switched on while the vehicle is turning. The right bending light is activated as long as the area "A" of prop. channel #2 is reached and is switched off, if the area "A" is left. The left bending light is switched on, if the area "D" is reached and is switched off again, when the area "D" is left.

The switching thresholds can be set below. Values between 5 and 100 are possible.

The option "Bending light via indicators" activates the bending light, as long as the corresponding indicator is active. Both variants can be combined.

When driving backwards both bending lights can be activated automatically.

The bending lights can also be used as fog lights.

Daytime running light:

The daytime running light can be controlled with the light switch.

Optional, the daytime running light can only be activated when also the engine sound (1 and/or 2) is on.

If the option "Reversing light only when driving" is activated, the reversing warning only lights up when the model is moving. The reversing light is then always off when the vehicle is in stationary. The same applies to the reversing warning sound and the automatic hazard warning lights.

A xenon effect can be activated for the low beam and high beam headlights. Here, when the light is switched on, the typical xenon effect (short flash followed by dimming up the brightness) is generated.

If desired, parking light and low beam headlight can always be switched on automatically as soon as the engine sound is on. If this option is activated, however, the parking light and low beam headlight can not be switched on or off, using the functions "Parking light " or " Low beam headlight "!

The ship light functions can be configured to detect automatically the condition of "in operation" or "at anchor" using the throttle channel #1. The condition "in operation" is automatically switched off, if the throttle channel is in neutral for a defined time. After the time has expired (1-255s), it will be switched for example from "in operation" to "at anchor".

The smoke generator can be activated automatically with the engine sound 1 or engine sound 2. If this option is not used, the smoke generator needs to be switched on/off separately with the function "smoke generator on".

For the output type "smoke generator fan" a trailing between 0 and 255 seconds can be set. This helps to keep the hose free of condensation.

Configuration - Outputs - Light switch

	Daytime running light	Parking light	Low beam headlight	High beam headlight	Front fog light	Rear fog light	Reversing light possible	Brake light possible	indicator possible	Black out headlamp	Guidance cross	Disguise rear light	Disguise brake light
Step: 6		*	*		*	*	*	*	*				
Step: 5		*	*		*		*	*	*				
Step: 4		*	*	*			*	*	*				
Step: 3		*	*				*	*	*				
Step: 2		*					*	*	*				
Step: 1	*						*	*	*				
Step: 0							*	*	*				

With the light switch various lights can be controlled with the function "light switch +" and "light switch -".

The light switch has in total 11 steps, which can be individually programmed. The steps are divided in 6 positive and 4 negative steps. The number of steps that should be used, can be selected as well as the active lights in each step. An active output is indicated with a "*" in the table.

For **"reversing light possible", "brake light possible" and "indicator light possible"** a „★“ does not mean that the lights are always switched on. Only when the corresponding function is triggered, the lights will be activated.

In the standard setting for step -1 to -4 (blackout lighting for military vehicles) reversing, brake and indicator lights are for example completely switched off.

All other lights are actually switched on if there is a „★“ at the step.

After turning on the sound module the light switch is automatically in step 0. With the reset button all settings are reset to standard.

Configuration - Outputs -Sequences

Step	Duration	Output 4	Output 8	Output 13
01	0,30 s	100%	0%	0%
02	0,30 s	0%	100%	0%
03	0,30 s	0%	0%	100%

Total steps:
 Loop start:
 Loop end:
 Stop immediately
 Outputs in sequence 1:
 1 2 3
 4 5 6
 7 8 9
 10 11 12
 13 14 15
 16

Step	Duration	Output 10
01	1,00 s	4%
02	0,10 s	50%
03	0,50 s	4%
04	0,20 s	70%
05	0,40 s	4%
06	0,10 s	100%
07	0,05 s	80%
08	0,05 s	60%
09	0,05 s	40%
10	0,05 s	20%

Total steps:
 Loop start:
 Loop end:
 Stop immediately
 Outputs in sequence 2:
 1 2 3
 4 5 6
 7 8 9
 10 11 12
 13 14 15
 16

With the SFR-1 up to 16 outputs can be combined and activated in a defined sequence (duration and intensity). This can be parallel or in a row. In total 8 output sequences can be programmed, each with 36 steps.

The sequence is always executed with priority to other output functions. All other outputs are deactivated as long as the output sequence is running.

On the right side the outputs that should be used for the sequence can be selected and they appear automatically in the step-table.

Total steps

For each sequence, the number of steps can be set here. In each case, up to 36 steps are possible.

If you activate the sequence, the steps will start with step 1 and run sequentially.

In each step you can set for each output the desired intensity. For this purpose, click with the mouse on the value that you want to change and select in the drop-down box the new value (0% - 100%).

Likewise the duration for each step can be specified between 0,01s and 24,6s.

Loop start and loop end

Similar to the three-stage additional sounds, the complete sequence can be divided into three sections:

1. Start sequence
2. Loop
3. Stop sequence

In the table, these three sections are stored colored in red and green for easy identification.

First the start sequence (red) is shown when turning on the output sequence and then the loop (green) as long as the sequence is still active. If the sequence is turned off, still the stop sequence (red) will be shown at the end.

Loop start and loop end, can be set individually. If the three-stage option should not be used, the loop start must be set to one and loop end to the number of set steps in order to make the whole sequence run through.

Stop immediately

This option determines whether turning of the sequence will stop it immediately, or it will last up until the end of the loop.

If you click with the right mouse button into the table, additional functions are offered:

Delete step	Deletes the step on which you clicked with the right mouse button. All other steps are shifted one row upwards.
Insert step	Inserts a new step before the step, on which you clicked with the right mouse button. All other steps are shifted one row downwards.
Copy this output to other output	The complete sequence from an output can be copied with this command to another output.
Export sequence	Use this to save a complete sequence in a file (*.a_seq) on your hard disk.
Import sequence	This opens a saved sequence (*.a_seq) again.

You can see two simple examples for output sequences on the picture on the previous page.

Output sequence 1:

This sequence is a simple rotating light with three lamps/LEDs. In the first step only output 1 is switched on. In the second step output 1 goes off again, and output 2 is switched on. In the third step output 2 is switched off and output 3 is switched on.

After the third step, the sequence starts from the beginning and output 1 is switched on again. In this way, the light almost “turns” in a “circle”.

Output sequence 2:

This example shows a simple fluorescent lighting simulation. Here is only one output used, however, the lamp switches not only on and off but it simulates the typical start of a fluorescent lamp.

In step 1, the intensity is set to a small value (4%). This is supposed to represent the preliminary annealing of the tube. In step 2 the lamp tries to ignite, so it becomes shortly brighter (50%), but it does not make it yet and it becomes darker in step 3 again (4%). In step 4 is another ignition attempt (70%) which does not succeed. Therefore, the intensity in step 5 is set back to 5%. Only in step 6 succeeds the "tube" to ignite. The beginning and the end of the loop are now set exactly to this step 6. Thus, the sequence now plays only this step 6 (lamp on) as long as the sequence is turned on. Only when the sequence is turned off, the steps 7 to 10 are reached and the lamp goes off in several stages (80% → 60% → 40% → 20% → 0%).

These are just simple examples. Of course you can also expand such sequences much further to achieve even incredible effect.

Configuration - Servo outputs - Servos 1 + 2

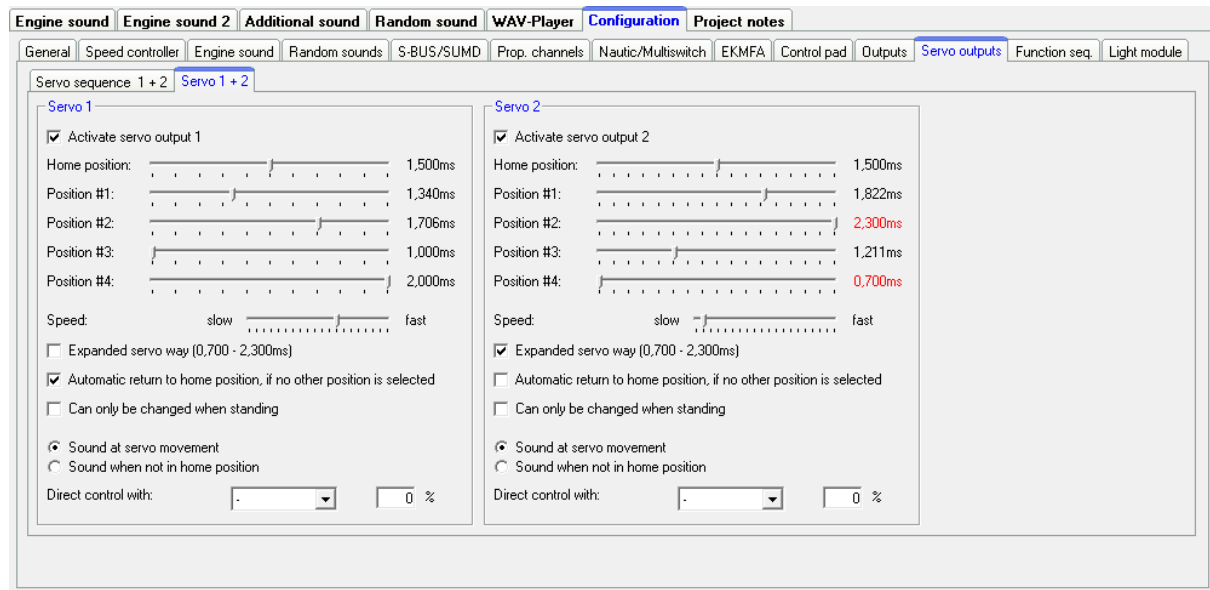

Here you can configure the two servo outputs of the SFR-1 (see page 47). If you want to use the servo outputs, you have to activate them here.

Home position

The servo goes always to the home position after turning on the SFR-1. With direct control via a prop. channel, the home position has a different meaning, see Direct servo control below.

Positions #1 - #4

These positions can be approached by functions (for example the proportional inputs, nautic/multiswitches or the EKMFA mode).

To move the positions, click with the mouse on the slider and move the pointer to the desired position.

Speed

The speed, with which the servo is moved, can be adjusted in 20 steps. It should be noted that each servo by itself has certain inertia. So even at maximum speed, a certain amount of time is needed to reach the selected position.

Expanded servo way

The usual length for a standard servo pulse is 1.000 to 2.000ms. Sometimes it is desirable to expand this area so that the travel is a bit increased. If this option is enabled, the servo positions can be set now between 0.700 - 2.300ms.

Caution!

Not all servos are suitable for this enhanced servo range and may get damaged! Therefore, use this function only with special care.

Go automatically to home position if no other position is selected

If this option is activated, the servo will go automatically in home position if currently no position #1 - #4 is selected.

If this option is not activated, the servo will not go back to home position during deactivation, but stays in the current position. This means, any position can be allocated to the servo. For this, the speed should be set relatively slow.

Change only while standing

With this setting, a servo movement is only possible as long as the vehicle is not moving. An accidentally sequence activation while driving can be prevented.

Sound at servo movement

If this option is activated, the additional sound for the servo will be played as long as the servo is moving.

Sound when not in home position

With this function the additional sound will always be played, if the servo is not in home position.

This version is very well suitable if you are using a speed controller with motor instead of a servo. In home position (1.500ms) the motor is switched off and no sound is played. For example, if position #1 is set to 1.800ms and you "select" this position, the motor will turn and you can play a corresponding sound.

Direct servo control

Both servo outputs can be controlled directly and stepless by one proportional channels. The prop signal from the receiver is passed on 1:1 to the servo. It is also possible to scale/limit the servoway between -100 % and +100 %. Negative values invert the running direction of the servo.

This is helpful for example to control a steerable axle. However, controlling a servo requires the complete proportional channel. No other function can be triggered with this proportional channel.

A sound can also be played during direct control via the Sound at servo movement and Sound when not in home position options. The value for the home position can be freely selected. This is necessary if a servo is always "parked", for example, on the far left and only turns to the far right when necessary, or if a flight speed controller is connected at the servo output. In this case, the home position is typically set to 1.000 ms and the sound is only played when this is left.

The home position here is not a single value, but a range of +/-0.050 ms around the set value, which avoids unwanted playback of the sound in the home position due to small fluctuations in the signal.

Connection of a mini speed controller to a servo output

To control motor movements and sounds of trailer supports, crane arm movements or tilt functions, a mini speed controller can be connected to a servo output.

The basic position indicates the state of the motor when the supply voltage is switched on. If the motor (which never occurs in practice) should turn in the neutral position, the slider must be moved to the left or right of 1.500 ms (motor off) in the home position.

The values in ms along the lines behind the positions #1 - #4 indicate the maximum engine speed. At the value of 1.000 ms and 2.000 ms, the engine is running forward or backward at full throttle. At 1.500 ms the motor is off. The positions #1 - #4 can be used to set different maximum movement speeds and directions of rotation.

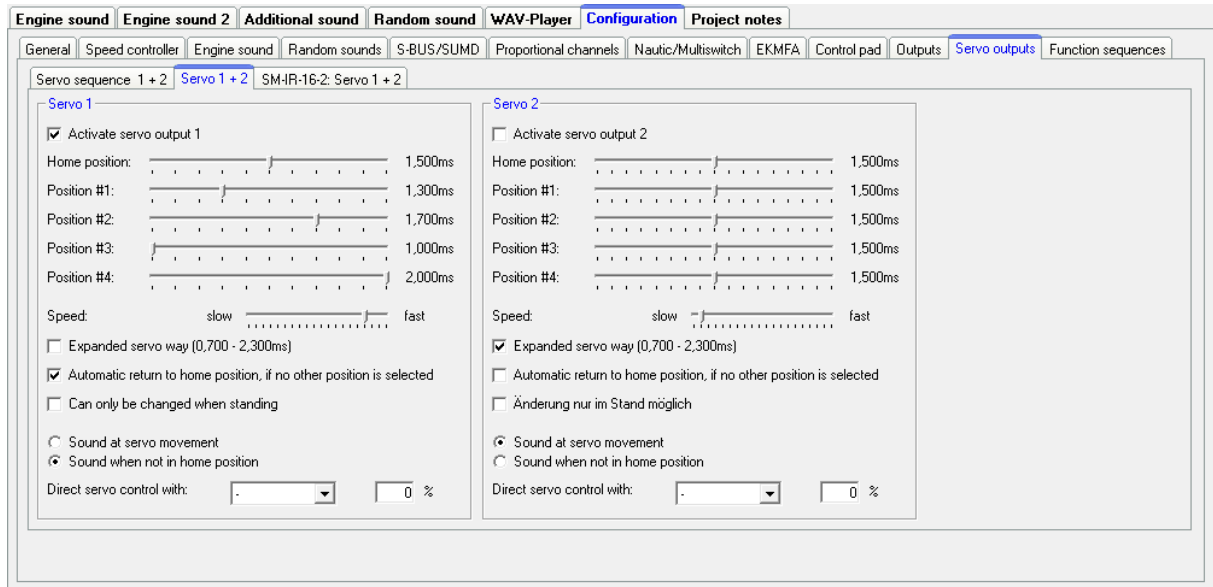

For #1 and #2, e.g. a crane arm will turn slowly to the right and left and at positions #3 and #4 quickly.

With "Speed" the acceleration (slow or fast) can be set from neutral (motor off) to the positions #1 - #4 (maximum rotation speed).

The motor can be operated proportionally with the direct servo control by a proportional channel.

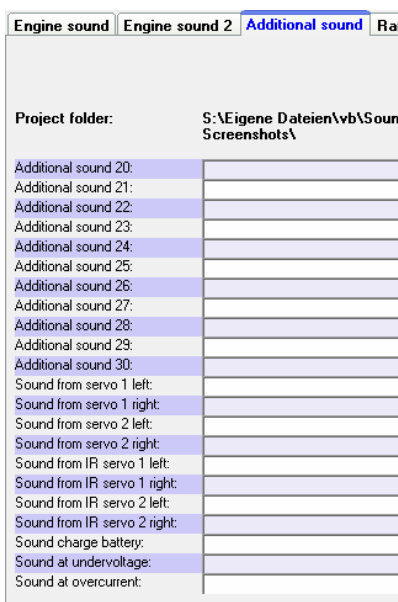

If the field "Sound when not in home position" is activated, the sound will be played as soon as the motor runs. The motor sound must be set in the sound slots under "Additional sounds" and "Sound from Servo 1 left", "Sound from servo 1 right", etc.

Finally the motor movement (forward/backward) must be started. This can be done via a proportional channel or a nautic/multiswitch. If the servo outputs are activated, they can be used in the function selection.

If the movement is activated/deactivated with a proportional channel, we recommended to use the function under "In position (static)".

Configuration - Servo outputs - Servos sequence 1 + 2

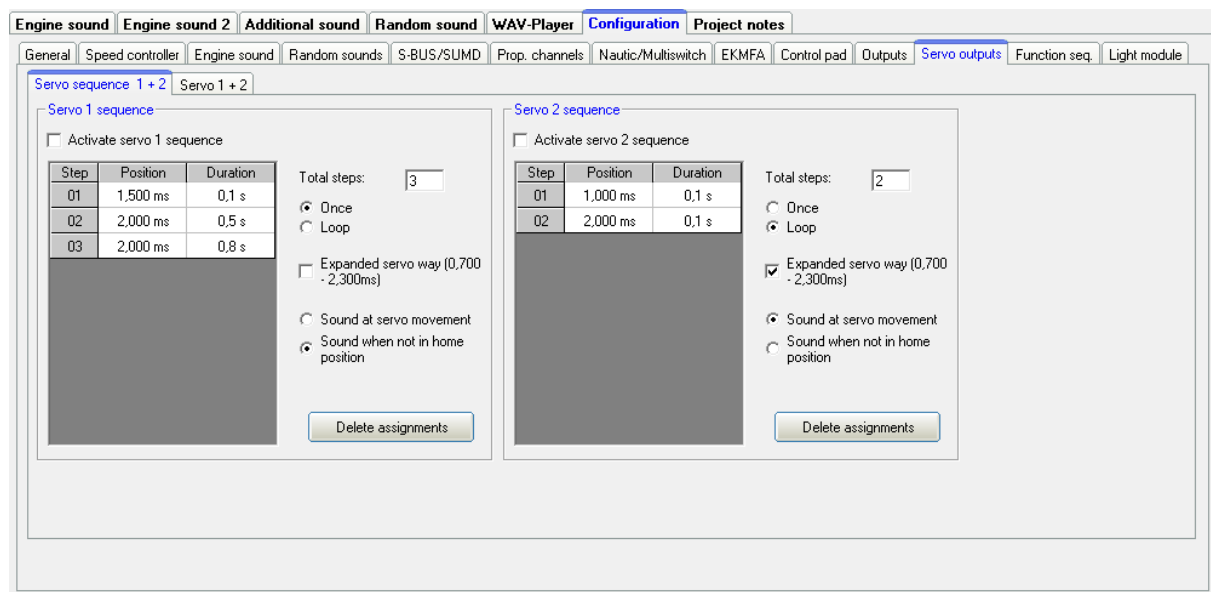

For both servo outputs you can program a time controlled flow sequences. A sequence may consist of up to 10 steps.

For every step a servo position (1,000 - 2,000ms) must be assigned, that indicates the starting position of the servo. Additionally the time must be defined for the servo movement from the current position to the next step/position. Both values give the speed of the servo movement.

The duration of the last step determines the time, the servo needs to move to the position of the first step.

The position of step 1 is the home position of the servo. Every sequence starts and ends from this position.

Once/Loop

Here it can be configured whether the servo sequence is only run once after it has been started (like a recoil of a tank during a cannon shot) or if the sequence continues in a loop (like a windshield wiper), as long as the start of the sequence is still present.

Expanded servo way

The normal pulse width for a standard servo is from 1.000 to 2.000 ms. Sometimes it is desirable to increase this area, and thus the travel distance too. When enabled, the servo positions can now be set between 0.700 - 2.300 ms.

Attention!

Not all servos are suitable for this enhanced servo range and may get damaged! Therefore, use this function only with special care.

Sound at servo movement

With this option the sound (additional sound) for the servo is always played as long as the servo moves. A distinction is made between servo movement to the left or to the right, i.e. different sounds can be played depending on the direction of rotation. If the same sound is to be played for both directions of rotation, the same sound file must be stored in both sound slots (left / right).

Sound when not in home position

With this option, the sound will be played when the servo is not in home position (position of step 1). A distinction is made between servo movement to the left or to the right, i.e. different sounds can be played depending on the direction of rotation. If the same sound is to be played for both directions of rotation, the same sound file must be stored in both sound slots (left / right).

The sound slots for "Sound at servo movement" and "Sound when not in home position" are identical. They are in the Sound-Teacher under "Additional sound", scroll down there completely.

If you click with the right mouse button in the table, the following additional functions are provided:

Delete step	Deletes the step you have clicked on with the right mouse button. All other steps are shifted up one row.
Insert step	Inserts a new step <u>before</u> the step on which you have clicked with the right mouse button. All other steps are shifted down one row.
Export sequence	With this, a complete sequence can be stored in a file (*.s_seq) on a hard drive.
Import sequence	With this, previously exported sequences (*.s_seq) can be read in again.

Example of previous page, servo 1 sequence: Recoil system of a tank

The servo 1 sequence shows an example of a simple recoil system of a tank. In step 1, the servo is placed in home position 1.000 ms (tank barrel ahead). Now, if the cannon shot sound is triggered, the sequence for servo 1 can be activated on this sound slot. After that, the servo moves very quickly (0.1s) to the position of Step 2: 2.000 ms (tank barrel at the back). The duration of step 2 is 0.5 s. Since the position of step 3 is also 2.000 ms, the servo remains in this position for this time (tank barrel remains shortly at the back). After the expiry of 0.5s, the sequence is now in step 3. Since this is the last step the servo moves slowly in 0.8s back to the home position 1.000 ms (position 1, tank barrel ahead again).

Example of previous page, servo 2 sequence: Windshield wiper

The servo 2 sequence shows an example for a windshield wiper. In step 1, the servo is placed in the home position, which is 1.000 ms (wiper down). If the sequence is triggered by using the function "Servo 2 sequence", the servo moves in 1.0s to the position of step 2, which means 2.000 ms (wiper at the top). Since this is the last step, the servo will move back to the home position (position 1) in 1.0s, which means back to 1.000 ms (wiper down).

Configuration - Function sequences

The screenshot shows the 'Configuration' window for the SFR-1. The 'Function seq.' tab is active, displaying 'Funktions-Sequenz 1'. The table below shows the sequence steps:

Step	Function	on/off	Duration
01	Additional sound 4 (lultbremse.wav)	on	0,01 s
02	Servo 1 Position 1	on	2,00 s
03	Servo 1 Position 1	off	0,01 s
04	Output 1	on	0,01 s
05	-	on	0,01 s
06	Output 1	off	0,01 s
07	Servo 1 Position 2	on	2,20 s
08	Servo 1 Position 2	off	0,01 s

Configuration options on the right:

- Total steps: 8
- Loop start: 5
- Loop end: 5
- Once
- Loop
- Loop / immed. stop
- retriggerable

A 'Delete assignments' button is located at the bottom right of the configuration area.

All functions of the SFR-1 (see page 25) can be compiled to a timed sequence of up to 36 functions/steps.

For each step a function can be selected and switched on or off. In Duration the time can be defined until the next step is activated. The duration of one step can range from 0.01 to 600 seconds.

It is possible to run the complete sequence or only certain steps as a loop. If the option "Loop" is activated the Loop start and Loop stop can be defined. The loop (green) is played as long the signal for the function sequence is activated.

If the function sequence is stopped while the loop is activated, the loop (green) continues to run to the end, then the (red) part, after the loop, continues to run through to the last step.

With the "Loop/immediate stop" option, the loop (green) is aborted at the current step when you stop and it jump directly to the first step (red) after the loop.

Important:

A function sequence will always run completely to the end. All functions that are not deactivated during the sequence remain switched on. If the "retriggerable" option is activated, a running function sequence starts again directly at step 1 when it is restarted.

Several function sequences can run simultaneously. It is also possible to start a function sequence from another function sequence.

With the right mouse button following commands are available:

Delete step	Deletes the step. All other steps are shifted one row up. The total step quantity is reduced by this step.
Insert step	Inserts one additional step <u>before</u> the step clicked on. All other steps are shifted one row down.
Export sequence	The complete sequence can be saved in a file (*.f_seq) on your hard disk.
Import sequence	Sequence files (*.f_seq) from your hard disk can be imported.

Configuration – Light module – Light module servos 1 + 2

The screenshot displays the configuration window for 'Light module Servo 1 + 2'. The window is divided into two main sections for 'Light module Servo 1' and 'Light module Servo 2'. Each section includes a visual representation of the servo's pulse width modulation (PWM) signal with specific timing values and a speed control slider. Below the visualizations are several checkboxes and radio buttons for configuring servo behavior, such as 'Expanded servo way', 'Automatic return to home position', and 'Sound at servo movement'. A 'Direct control with:' dropdown menu and a percentage input field are also present for each servo.

Parameter	Light module Servo 1	Light module Servo 2
Home position	0,964ms	1,500ms
Position #1	1,500ms	1,500ms
Position #2	2,053ms	1,500ms
Expanded servo way (0,700 - 2,300ms)	<input checked="" type="checkbox"/>	<input type="checkbox"/>
Automatic return to home position, if no other position is selected	<input checked="" type="checkbox"/>	<input type="checkbox"/>
Can only be changed when standing	<input type="checkbox"/>	<input type="checkbox"/>
Sound at servo movement	<input checked="" type="radio"/>	<input checked="" type="radio"/>
Sound when not in home position	<input type="radio"/>	<input type="radio"/>
Direct control with:	[Dropdown]	Prop #2
Percentage	0 %	70 %

The servo outputs of the light modules SM-IR-16-2, LM-IR-16-4 and LM-BT-16-4 can be configured similar to the servo outputs of the SFR-1.

For details about the settings please read page 82 onwards. The only difference is that the light modules has only 2 positions, #1 and #2. The positions #3 and #4 do not exist here.

Configuration – Light module – Light module motor



To control the motor output the light modules [LM-IR-16-4](#) and [LM-BT-16-4](#) there are 2 options:

1. Control the motor output using the "up" / "down" functions: Here the motor can be controlled using the two functions "LM: Motor up" and "LM: Motor down". If neither of the two functions is active, the motor stops. The speed of the motor can be set to a fixed value between 0 and 100%.
2. Control the motor output via a proportional channel: The motor output can also be controlled via a proportional channel. The speed of the motor can be continuously controlled with the selected channel. The motor output behaves like a speed controller here. The speed can also be limited. Values from -100% to +100% are possible here. A negative value reverses the direction of rotation of the motor.

Project notes

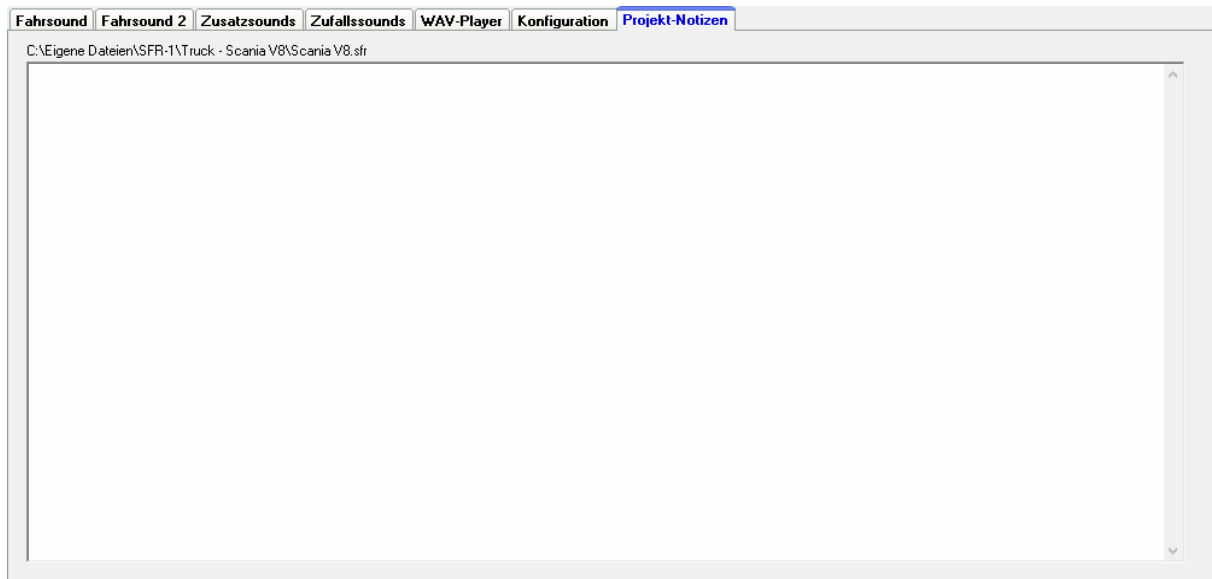

In project notes you have space for remarks about your project and settings.

Saving sounds and configurations on SD card

Please only use the SFR-1 Sound-Teacher to program the SD card and do not copy any files to SD card "by hand". Please do not delete any files on the SD card.

The sound module must be disconnected from the supply voltage before inserting or pulling out the SD card!

1. Pull out the SD card from the slot of the SFR-1. The card should be handled with care in order to prevent damage because the side with the golden contacts is very sensitive to scratches.
2. Insert the SD card in the card reader, which is connected to the PC.
3. Now start the SFR-1 Sound-Teacher and choose the desired project, the new sounds or setup the configuration.
4. Choose (if necessary) the drive letter of your SD card in the menu "SD card". If you have connected additional removable devices (such as SD cards or USB sticks) to your computer, please pay attention to choose the right device.
5. The Button „**Save project data onto SD card**“ is used to write all sounds and configurations onto SD card. This can take up to several minutes. The speed depends on the amount of data.
6. Now you can remove the SD card from the card reader and insert it carefully into the slot of the SFR-1. The golden contacts must face downwards.

Transferring configurations with data cable K-USB-2

If you often want to change sounds and configurations in the Sound-Teacher, it will quickly become annoying inserting and pulling out the SD card between SFR-1 and card reader. To avoid time consuming reconnecting, it is possible to transfer complete projects with the data cable K-USB-2.

In the menue „Data cable“ and „Upload project data via data cable“ or with the button „Transfer project data“ all sounds and settings are transferred onto the SD card.

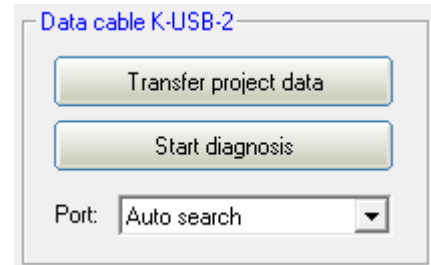

Transferring sounds with the data cable K-USB-2 takes a few minutes! A sound with a length of 10 seconds takes about 15 - 45 seconds (depending on the transmission speed) until it is transferred. Very long songs and large, new projects are only restrictively recommended to be transferred with the data cable.

If a completely empty SD card is inserted in the sound module (e.g. reformatted), the project cannot be written to the SD card with the data cable! An empty SD card must always be written to once in the card reader on the PC using the Sound-Teacher.

Problems with the data cable

If problems occur, the transfer speed can be reduced in the menue „Data cable“.

SFR-1 can not be found with data cable

If the SFR-1 port can not be found with the data cable, check the port in the device manager. If there is a yellow warning sign a new hardware driver (Prolific) is required.

Windows:

With Windows 10 and later versions no additional hardware driver is required. For older operating systems the hardware driver can be dowloaded on our website at the product page data cable [K-USB-2](#).

Linux:

In combination with Linux, the data cable can also be used with the software [Wine](#). No extra hardware driver is required, however a COM port must be set using following comand in your terminal window:

```
sudo chmod 777 /dev/ttyACM0
sudo ln -s /dev/ttyACM0 ~/.wine/dosdevices/com5
```

Mac OS:

The data cable is compatible with Mac OS in combination with the software [WineBottler](#). No extra hardware driver is required, however a COM port must be set using following comand in your terminal window:

```
sudo ln -s /dev/cu.usbmodem9f31 ~/Wine Files/dosdevices/com5
```

Adjustments of driving sound with the driving sound diagram

The screenshot shows the 'Configuration' tab of the SFR-1 software. The 'Engine sound' section is active, displaying various settings for engine sound options and speed steps/gears. The 'Engine sound options' section includes thresholds for slow down, speed up, brake noise, and cornering squeak, along with checkboxes for fast switching and automatic motion-based sound control. The 'Speed steps / gears' section shows 3 forward gears and 1 backward gear, with a zero point deadband of 5. A driving sound diagram is displayed, showing a blue line representing the play-back speed of the driving sound across different driving sound (FG) ranges. The diagram has a horizontal axis for driving speed (backward to forward) and a vertical axis for play-back speed (60% to 300%). A green vertical line at 0% indicates the neutral position. Red vertical lines mark the boundaries of driving sound ranges FG1, FG2, and FG3. Small red and blue quadrates at the bottom of the diagram indicate the play-back speed at the boundaries of these ranges.

With the driving sound diagram you can set:

- The neutral position of your joy sticks.
- The beginning and end thresholds including the corresponding sound for each driving sound (FG1 – FG5).

Explanation of the Diagram

The diagram consists of two axes:

1. The horizontal axe (x - left to right) shows the driving speed of the model (respectively the position of the throttle stick).
2. The vertical axe (y - from down to up) shows the play-back speed of the driving sound. The range starts at 60% and goes up to 300 %. This percent refers to the play-back speed of the driving sounds (100 %) saved in the SFR-1 slots. A higher play-back speed (e.g. 150 %) equals a higher engine speed.

Explanation of the different coloured lines and quadrates in the diagram

Green line

The green line indicates the neutral position of the throttle stick. Using the blue setup button/function the neutral position of the throttle channel is set automatically. As long as the throttle channel is in the neutral position, the module idles and the SFR-1 plays the idle noise.

Red lines

The red lines on the outside left and right represent the maximal driving speed (backwards and forwards). The other red lines with small red quadrates at the bottom indicate the driving speed at which the driving sound/gear should be changed.

The thresholds can be adjusted with the red quadrates. As soon as the driving speed reaches the speed at the red line, a change of the driving sound takes place. Depending on the number speed steps/gears the same amount of red lines will appear.

Blue lines

The blue lines show the play-back speed (60 % - 300 %) of the driving sound correlating to the model speed. 100% represent the original play-back speed (the same speed as the original sound in the slot). At 300% the sound is played three times as fast as the original sound and the engine „sounds“ faster. At values smaller than 100% the sound is played more slowly.

On the right and on the left of each blue line is a blue quadrate where you can set the start and end play-back speed for each driving sound. At these quadrates you can set the different speeds with the left mouse button.

If the cursor is on one of the coloured quadrates further explanations of the value and the current value occurs below the diagram.

Approach of setting the driving sound

1. Adjustment of speed steps/gears:

Set the required speed steps/gears for backwards and forwards in the Sound-Teacher.

2. Adjustment of thresholds:

If more than one speed step/gear is used, additional red lines occur automatically in the driving sound diagram to set the thresholds for each sound (FG1-FG5).

3. Adjustment of start and end speed of the play-back speed of driving sounds:

The play-back speed of driving sounds can be adjusted by shifting the blue quadrates in the diagram. The sound can be adjusted to the driving speed of the model.

4. Control of driving sounds:

Check if all slots are occupied with the necessary driving sounds. For example if you like to have three gears for your driving sound you need to use FG1 - FG3 for your different sounds. Otherwise your sound module will get problems with finding the different sounds. The "FG1 normal" sound slot must always be assigned a sound, otherwise there will be no sound when driving.

Perhaps we would like to point out that fewer gears (max. 2 or 3) usually sound better than too many gears. The more gears are used, the slower and more sensitive you have to accelerate. Theoretically, you can bring the throttle stick on the radio from neutral to full throttle within a second, but this sounds completely unrealistic in terms of sound. A real vehicle needs a much longer time to accelerate from standstill to full throttle.

Sound simulation

The sound simulation can be started with a click on “Sound simulation” in the menu “Help”.

You can play-back the driving sounds and the additional sounds 1 to 30 of your current project at your pc. This is an easy way to check your sounds and configurations without copying all files to SD card.

The driving sound can be switched on and off and even the driving speed can be simulated by the slider.

To trigger an additional sound, just click on the corresponding button. The additional sounds can also be triggered by the keyboard:

- Button F1 - F10 → Additional sound 1 - 10
- Button 1 - 0 → Additional sound 11 - 20

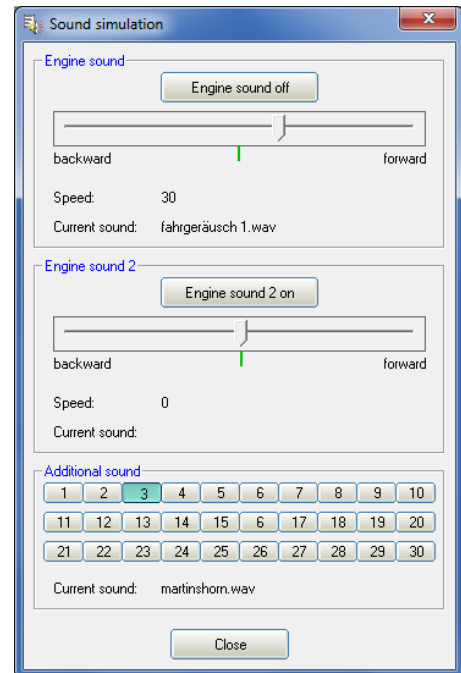

Testing functions with help of data cable K-USB-2

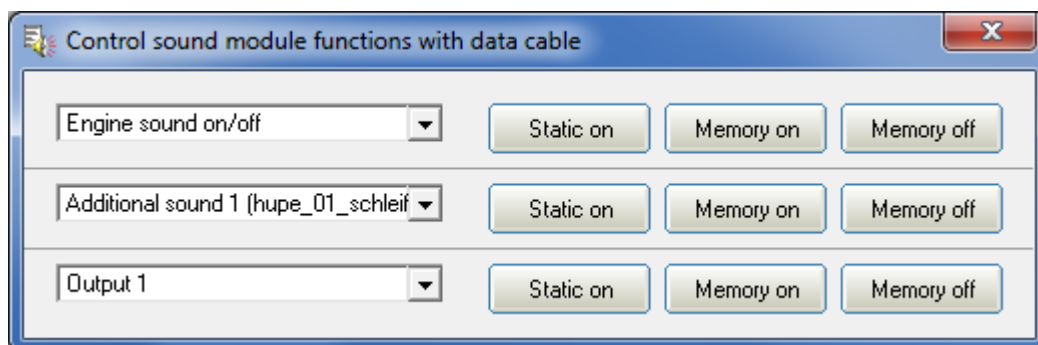

The function “Control SFR-1 functions with data cable” can be found under menu “Data cable”. With the help of the data cable K-USB-2, all functions can be controlled directly from the PC and not only via the remote control. This can be very helpful for tests without transmitter.

As usual, the functions can be selected with drop boxes. It is possible to activate the functions static or in memory at the SFR-1.

Diagnosis

A diagnosis function is integrated in the SFR-1 to control different functions, values and features.

There are two different types of diagnosis:

1. Diagnosis with datacable (live)
2. Diagnosis with SD card (recorded)

The diagnosis window is divided into different areas: proportional channels, outputs, servo outputs, motor, nautic mode and others.

Proportional channels

The first slot shows the received values of the 6 or 16 (with sum signals) proportional inputs/channels from the transmitter. The values range between 1.000 and 2.000 ms.

In neutral position the values of the next (middle) slot should be around 0.

In addition, a letter is displayed. This letter indicates in which of the 5 areas (A, B, N, C and D) the channel is located. This is very helpful for troubleshooting if some sounds or functions can not be switched correctly via the proportional channel.

A slight fluctuation of the values is quite normal and does not indicate a problem!

Servo outputs

These values show the position of the servo. They range between 1.000 and 2.000 ms. The neutral position is 1.500.

Motor

Some values of the motor output stage are shown here. They are intended primarily for internal audit purposes.

Nautic mode

If the nautic mode is active, you can see the received nautic signals here by pressing on „read“. This is only necessary in a few cases, e.g. if you want to analyze a new switching module, or if errors occur at the transmitter side in nautic mode.

The screenshot shows the 'Diagnose' window with the following sections:

- Proportional channel:** A table with columns for channel number, received value (ms), a letter indicator, and neutral value (ms).

Ch. #	Value (ms)	Letter	Neutral (ms)
Ch. #1:	1,501 ms	2	1,500 ms
Ch. #2:	1,528 ms	5	1,500 ms
Ch. #3:	1,891 ms	79 A	1,500 ms
Ch. #4:	0,000 ms	0 N	1,500 ms
Ch. #5:	0,000 ms	0 N	1,500 ms
Ch. #6:	0,000 ms	0 N	1,500 ms
Ch. #7:			
Ch. #8:			
Ch. #9:			
Ch. #10:			
Ch. #11:			
Ch. #12:			
Ch. #13:			
Ch. #14:			
Ch. #15:			
Ch. #16:			
- Neutral:** A column of values, mostly 1,500 ms.
- Servo outputs:**
 - Steering servo: 1,528 ms
 - Servo 1: 1,500 ms
 - Servo 2: 1,500 ms
 - IR-Servo 1: 0,964 ms
 - IR-Servo 2: 1,517 ms
- Engine:**
 - Motor voltage: 0
 - Set value: 0
 - Value: 0
 - PWM: 0,0 %
 - Braking PWM: 100,0 %
 - Load regulation:
 - Cruise control:
 - Braking function:
 - Hand brake:
- Outputs:** A grid of 16 outputs, each with a status indicator (green dot for active, grey dot for inactive). Output 4 and 5 are active.
- Miscellaneous:**
 - Firmware: 1.01a
 - Error code: 0
 - Temperature: 25° C
 - Battery voltage: 7,1 V
 - Battery threshold: 6,4 V
 - Output current: 0,00 A
 - Volume pot: 100 %
 - Volume (software): 100 %
 - Speed: 0 0
 - Tab-Pos / Speed: 127 136 136
 - Sound-Nr.: 0 0 101 0
 - Hysteresis: 0
- Nautic mode:** A text area with a 'read' button.
- Recorded diagnosis on hard disk:** A progress bar showing 000.000 s, with 'Start recording', 'Play recording', and 'Close' buttons.
- Status:** A green dot and text 'Connected - Live Diagnosis'.

Outputs

If one of the 16 outputs are switched on, it will be indicated with a green circle.

To check all 16 outputs one by one you can activate the box „Test“. This is helpful to control your wiring without using the transmitter. This diagnosis function works only with live diagnosis and a data cable.

Miscellaneous

The values shown here are intended primarily for internal audit purposes.

Live-diagnosis with datacable

The additional datacable K-USB-2 is needed for live-diagnosis. It is connected to X11. The brown cable points to the SD-card.

A live-diagnosis using the data cable is generally only useful when the SFR-1 in the model is completely installed; wired and all necessary equipment is switched on (e.g. transmitter and receiver).

Approach for diagnosis using the datacable:

1. Switch on transmitter (and receiver).
2. Connect SFR-1 to supply voltage.
3. Connect datacable to X11 and to your computer.
4. Start SFR-1 Sound-Teacher.
5. Go to "Data cable" and click on "Diagnosis via datacable".
6. The diagnosis window opens.

Optionally, the live diagnosis can also be recorded on the hard disk of the PC and played back later.

Record diagnosis with SD card

You can also record diagnosis data from the SFR-1 to the SD card. This data can be displayed with the Sound-Teacher on the computer.

Consider following points:

- The must be enabled first in the Sound-Teacher.
- Since the recording of diagnosis data stresses the processor, it might come to interrupts in the sound playback. So this function should only be used for troubleshooting and afterwards switched off.
- A maximum of 10 minutes can be recorded (1 separate record every 10 ms).
- Each time the supply voltage is switched on, the old diagnosis data is deleted and the recording starts again.

Approach for diagnosis using the SD card:

1. Activate "Record diagnosis data on SD card" in the Sound-Teacher „Configuration“ → „General“. Save and transfer the projectdata onto SD card.
2. Insert SD card in the SFR-1.
3. Switch on transmitter.
4. Connect SFR-1 to supply voltage.
5. Now a maximum of 10 minutes can be recorded to SD card (red LED flickers slightly).
6. Activate and deactivate different functions. Document the function and time.
7. Disconnect SFR-1 from power supply.
8. Remove SD card.
9. Start the Sound-Teacher.
10. Insert SD card to the cardreader of your computer.
11. Go to "Data cable" and click on "Diagnosis via SD card".
12. The diagnosis window opens.
13. With the slider at the bottom, the diagnosis data can be displayed at any time of the recording.

Firmware update

The sound-Teacher writes the firmware file automatically while saving the project data onto SD card.

A firmware update of the SFR-1 is always performed automatically when the Sound-Teacher version is different from the current version of the SFR-1 firmware. The firmware update will be started after the supply voltage is switched on and it takes 10 seconds. The red and blue LEDs flashes during this period a few times alternating.

Never disconnect the sound module from power supply while updating!

A new firmware is mostly included if you are using a new version of the Sound-Teacher. If you are using a new version of the Sound-Teacher, take care that on the first turning on of your sound module, the firmware might be updated. Therefore the voltage should not be turned off for at least 10 seconds!

How to create new sounds

On the supplied DVD-ROM there are plenty of sounds with which you can make your first attempts with the sound speed controller. At some point you will certainly want to play your own sounds on your sound speed controller.

The Internet, for example, offers an almost infinite amount of sound data, which you can usually download free of charge and then transfer to your sound speed controller.

Simply enter the desired sound in connection with the term "download" in a search engine (<http://www.google.com>).

The website <http://www.youtube.com> offers a large database of videos, which often contain usable sound material. However, another program is required to be able to save the sounds from the videos on the PC. The **"Free YouTube to MP3 Converter"** program is located on the supplied DVD-ROM for this purpose.

To install the software, start the "USM Installer", click on "Install Free Youtube to MP3 Converter" and follow the instructions on the screen.

If there are problems downloading the sounds, the software may need to be updated or the download may not be condoned by the author.

The following example explains how to download a sound using the "Free YouTube to MP3 Converter" program.

1. Go to the website <http://www.youtube.com>
2. Enter a suitable search term in the search.
3. When you have found a suitable video, copy the current Internet address of your browser to the clipboard (Ctrl + C).
4. Now start the program "Free YouTube to MP3 Converter" and click on "Paste".
5. If the insertion was successful, the target directory in which the sound is to be saved can be set under "Options" in the "Output" menu.
6. Click on "Download" to save the file in the target directory.
7. Wait until the file has finished downloading.

Please note that we are not the developer of the "Free YouTube to MP3 Converter" program, do not have any rights to it and cannot offer any further support for this product.

You can also record your own sounds with a microphone, for example with the software „Audacity“.

The supplied DVD contains a full version of Audacity. To install the software, start the "USM Installer", click on "Install Audacity" and follow the instructions on the screen.

This is freeware that you can use without restriction. Extensive sound processing is also possible with the program. Further information about this software can be found on the developer's website: <http://audacity.sourceforge.net/?lang=de>

Please note that we are not the developer of the “Audacity” software, have no rights to it and cannot offer any further support for this product.

The following example explains how you can record sounds with the “Audacity” software.

1. Start the program "Audacity"
2. Select a recording device (to the right of the microphone in the "Recording devices" toolbar).
3. On the top right of the picture next to the microphone is the volume control for the recording. Set the volume here so that the recording is optimally controlled. Experience has shown that the slider is usually in the upper third. The level display should not reach the maximum value when recording. The highest value is shown as a blue line.
4. Control elements:

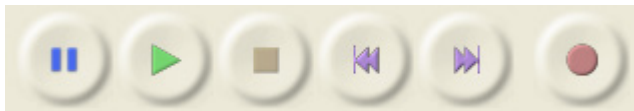

The recording is started by clicking on the record button (red dot). A working recording can be recognized by the fact that the level indicator moves and a blue curve is recorded.

There can be several reasons if the recording is not working:

- Sometimes Audacity has problems recording in mono. Therefore select “2 (Stereo) Channels” as input channels.
- Check that the recording device is present and activated. In Windows XP, double-click the loudspeaker symbol in the lower right corner of the system tray. This opens the "playback controls". Click on “Properties” in the “Options” menu. Now select "Recording" and activate the device to be used. In Windows Vista / 7 you have to right click on the loudspeaker symbol and select “Recording devices”. Then right-click in the white window and check “Show deactivated devices”. If the recording device used is not displayed, a new driver for the sound card may help. Now set the recording device as under point 2.
- If you want to record a sound that is currently being played on your PC (e.g. from the Internet), you must select "Stereo Mix", "Record Sum" or "Wave" as the recording device. This designation varies depending on the manufacturer of the sound card.

Troubleshooting:

5. Check whether the volume setting you made under point 3 was correct. If necessary, correct the volume setting as described above.
6. Click the stop button (brown square) to stop the recording again.

7. The waveform of the recorded sound is shown in blue. You can listen to the recorded sound by clicking the play button (green triangle).

The sound can now be edited using the extensive functions of the software. In addition, the sound must also be converted into the appropriate format. The conversion and editing of the sounds is explained on the following pages.

How to convert sound files

If the sound files are not available in the required format, they must be converted before they can be read by the sound speed controller.

Any sound processing program that offers the required functions can be used for this purpose.

Using the “**Audacity**” program, we will now briefly explain how an existing sound file is converted:

1. Start the program "Audacity"
2. Open the sound file you want to convert.
3. If 2 audio tracks can now be seen, it is a stereo track.
4. This stereo track needs to be converted to mono.
5. To do this, click in the “Tracks” menu on “Convert stereo track to mono”.
6. Set the "Project frequency (hz)" at the very bottom left. Select 44100 there.
7. Now save the file under a new name:
 - To do this, click on "Export ..." in the "File" menu.
 - Specify in which folder and under which name the file should be saved.
 - Under "File type" select "WAV (Microsoft) 16-bit PCM".
 - Now confirm your selection with "OK" and save the file.
8. In the "Edit metadata" window, please do not enter anything in the fields or delete existing values. Otherwise the WAV files cannot be played using the sound simulation in the Sound-Teacher!
9. Now the newly created file can be edited further with Audacity or loaded directly with the software "SFR-1 Sound-Teacher".

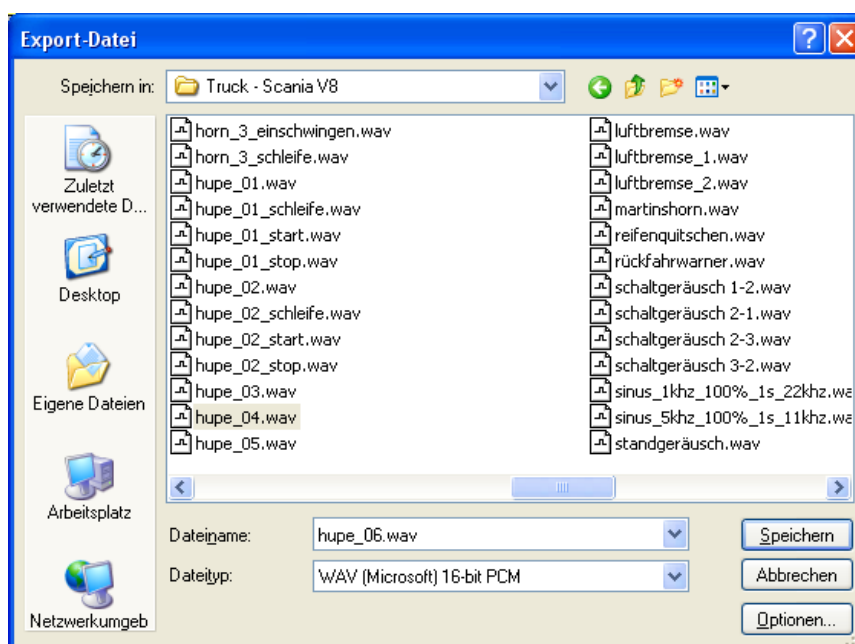
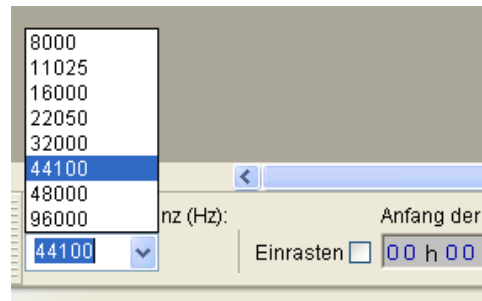

How to edit sounds with the PC

"Amplify" sounds

So that the sound is played loud enough, the sound must be controlled accordingly. In practice, it has been shown that a certain amount of overdrive does not immediately deteriorate the sound quality, but of course increases the volume.

Poor controlled sound:

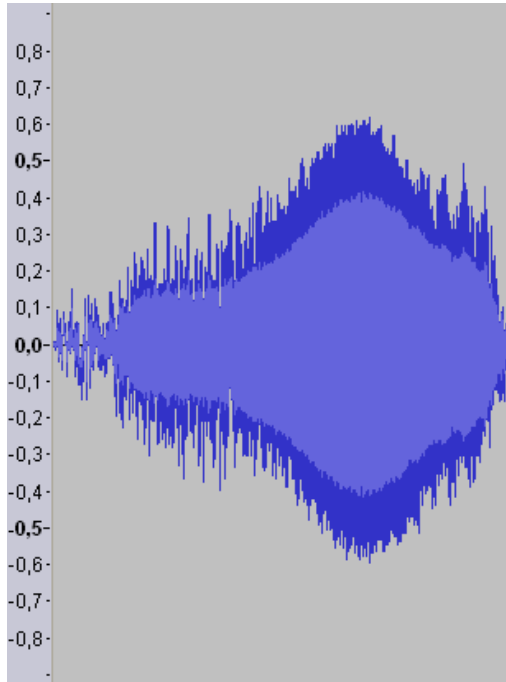

Good controlled sound:

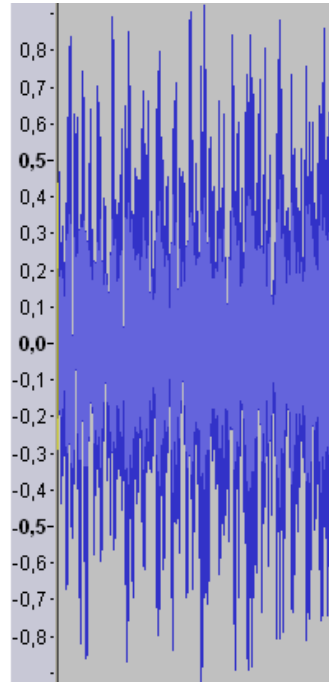

The sound on the right could also be further amplified without significantly affecting the sound quality, since only a few peak samples would be lost.

To amplify a sound with Audacity, proceed as follows:

1. If the sound is not well controlled over its entire length, it should first be "normalized". In the "Effect" menu, select "Normalize..." and confirm your selection with "OK".
2. In the "Effect" menu, select the "Boost ..." item.
3. Activate the "Allow override" field.
4. The gain must be specified in "dB".
5. However, the unit dB is not linear. 3 dB correspond approximately to a gain of 40% and 6 dB to 100%.
6. Confirm your selection with "OK".
7. Changes can also be easily undone using the key combination "Ctrl + Z".

"Cutting" sounds

To create usable sounds, it is often necessary to cut out or remove individual parts of the soundtrack. For this you need:

1. The selection tool for marking



2. The zoom tool to enlarge



Method:

1. Use the zoom tool to choose a part of the sound that you want to use (left click to zoom in, right click to zoom out)
2. You can move through the audio track with the scroll bar at the bottom of the screen.
3. Select the selection tool and use the left mouse button to mark the area that you want to use.

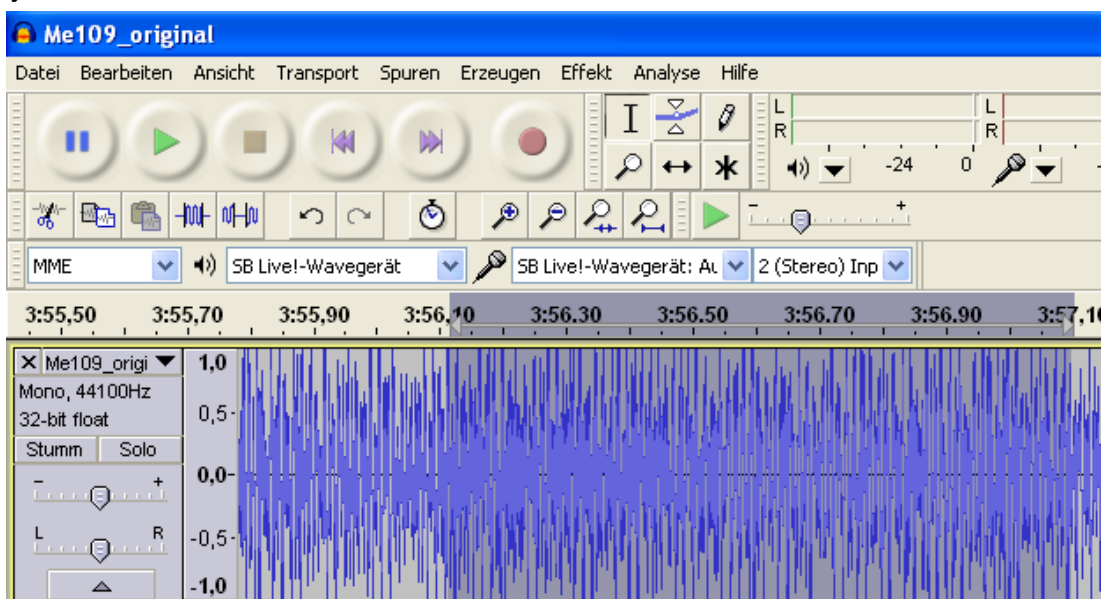

4. Use the play button to check the selection.
5. Corrections can be made with the selection tool. Use the white hand that appears at the edge of the marked area as soon as you move the mouse there.
6. Select "Trim" in the "Edit" menu to delete all unmarked parts of the sound.
7. To arrange the remaining section on the left, go to "Align Tracks" in the "Tracks" menu and select "Align to Zero".

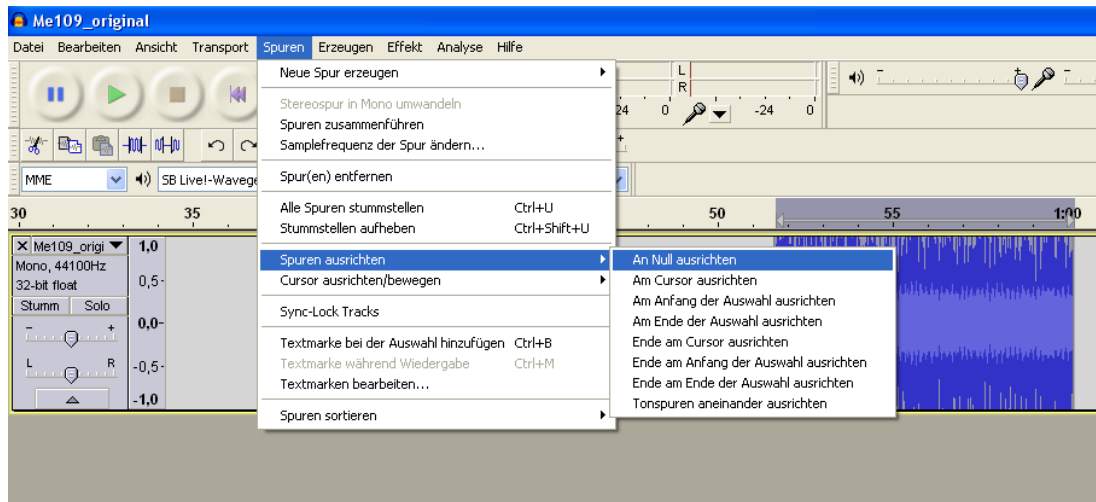

- If something should be deleted, use the selection tool to mark the part that is no longer required and click on **“Delete”** in the **“Edit”** menu.

Create simple driving sounds

A "very simple" driving noise consists of a starting noise, the loop of the stationary / driving noise and a stopping noise. The loop is then used for the stationary and driving noise.

First of all, you need a usable recording that includes both a start, a steady loop for the stationary noise, and a shutdown. The following example is intended to demonstrate how to create a usable driving noise from a recording.

- Open the recording and, if necessary, carry out an "amplification".
- Convert the sound to wav format and save this "original sound".
- Close the original sound and open it again immediately. The settings (e.g. the sample rate) of the original sound are then adopted for the project.
- Listen to the sound carefully and look for a suitable starting noise. Bear in mind that the starting noise should later merge into the loop of the standing noise, if possible without a transition. It is also a good idea to make a note of the end time of the marking. From here the loop for the standing noise should start later. Under the scroll bar of the sound track, you will see 3 windows that will help you. These windows show you at what time the current selection begins, where it ends, or how long it is. First select "End", then click with the right mouse button on the middle window and set the format there as shown in the adjacent picture.
- You can now read the beginning of the marking in the left window and the end in the right window. Make a note of the end.
- Then cut out a suitable starting noise.
- In order to improve the starting noise, a "fade in" can be created at the beginning. To do this, for example, mark the first 0.2 seconds of the soundtrack and select the "Fade in" item in the "Effect" menu.

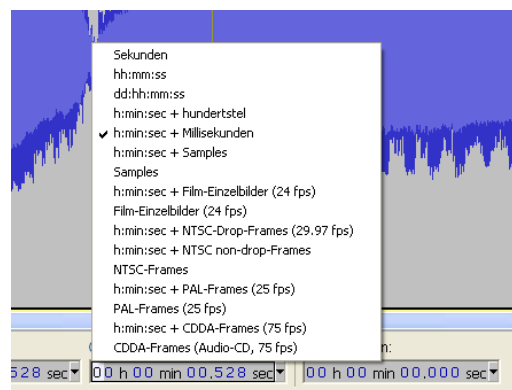

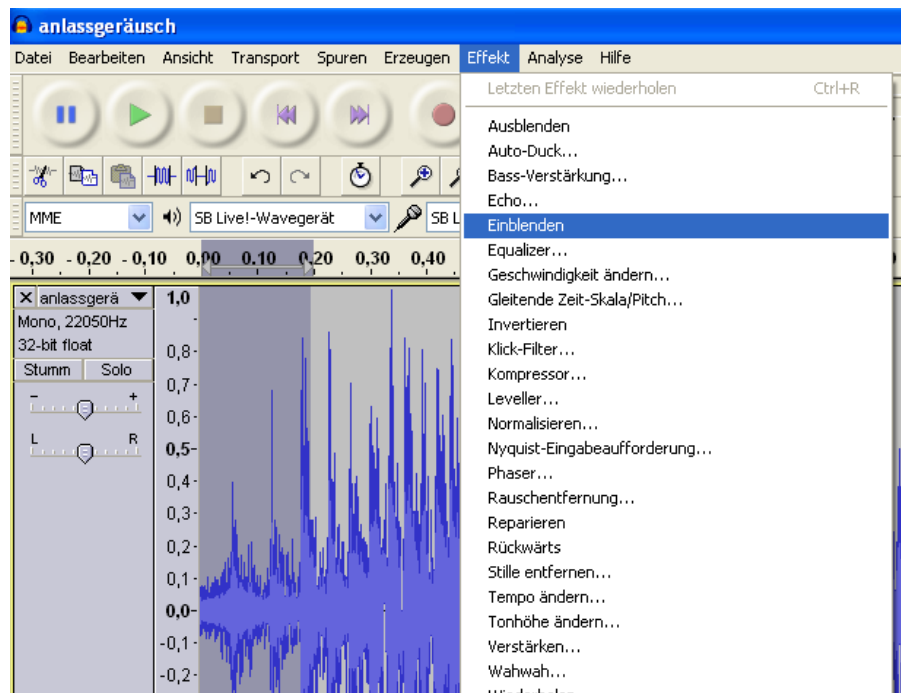

8. Observe how the signal course has changed:

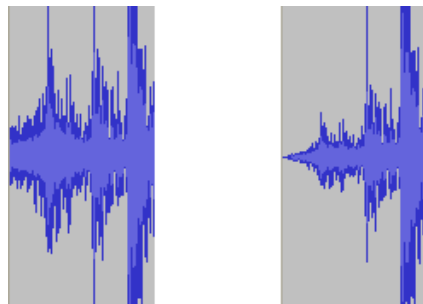

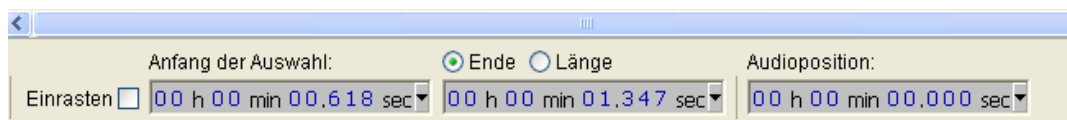

9. Export the finished starting noise and save it in the correct format under a new name (eg "anlassgeräus.wav").
10. Then open the original sound again and select a suitable loop for the standing noise. The loop should start from the end time of the cranking noise. The end time of the start-up noise should therefore be under "Start of selection".



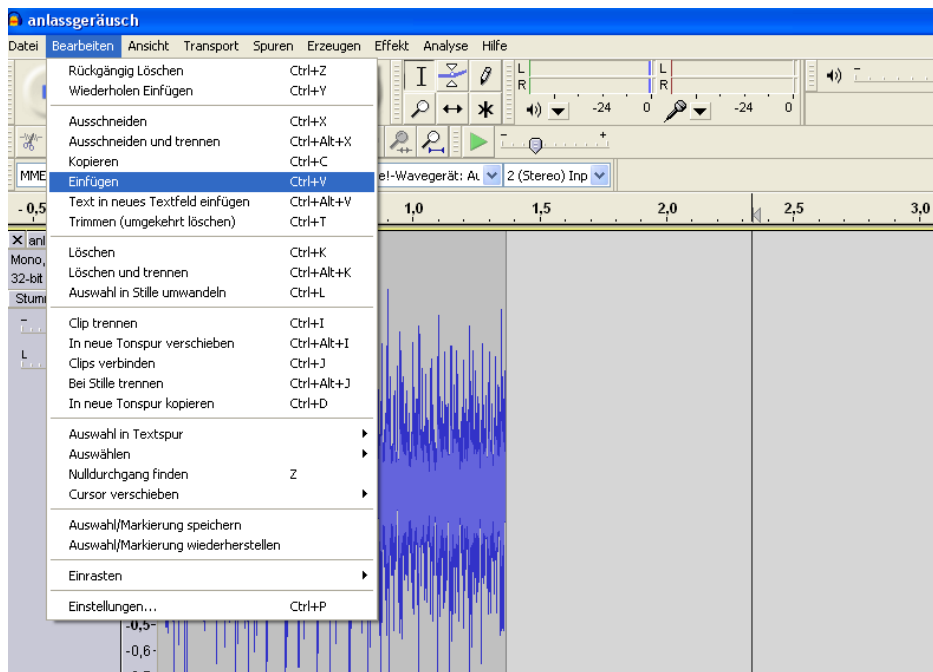

11. Experience has shown that the length of a loop should be between 2 and 6 seconds.
12. You can listen to the highlighted loop as an endless loop by holding down the Shift key and pressing the green play key.
13. The loop should merge into one another without "cracking" or audible differences. If this is not the case, there are various "tricks" to improve the loop:
 - a. First save the loop in a new file (eg "standgerärm.wav").
 - b. Mark the entire loop with the selection tool and select the "Copy" item in the "Edit" menu.

- c. Then click to the right of the soundtrack in the free area and then select “Paste” in the “Edit” menu.

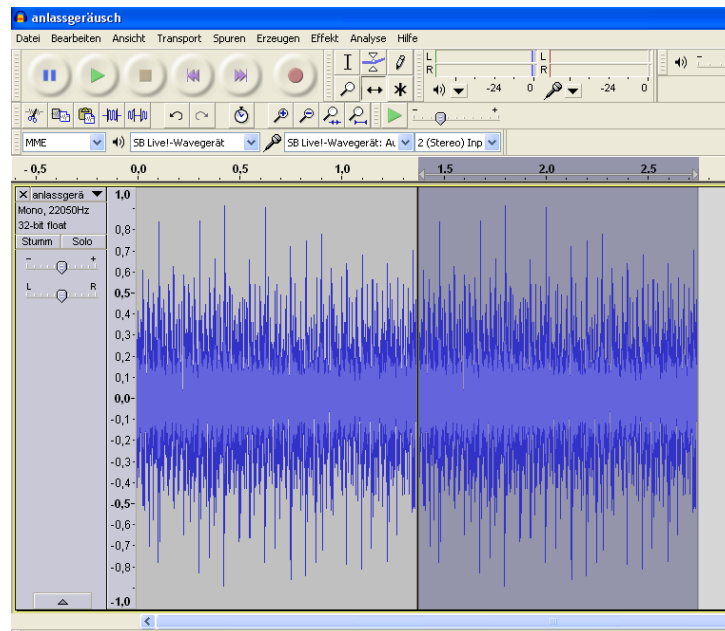

- d. Now select “Backward” under “Effect”.
- e. Next, invert the inserted track using “Effect” and “Invert”.
- f. The inserted track must now be merged with the existing one.
- g. Use the move tool for this  and move the right lane to the left. With a click on the black line between the tracks, they are merged.



- h. Listen to the loop again.
- i. Use the zoom tool to find "cracking spots" and try with the help of the drawing tool  to improve this.
- j. Such points can arise from jerky transitions in the sound track, or if the end point and the start point of a loop are far apart
- k. Typical cracks look like this, for example (image on the right strongly zoomed in):

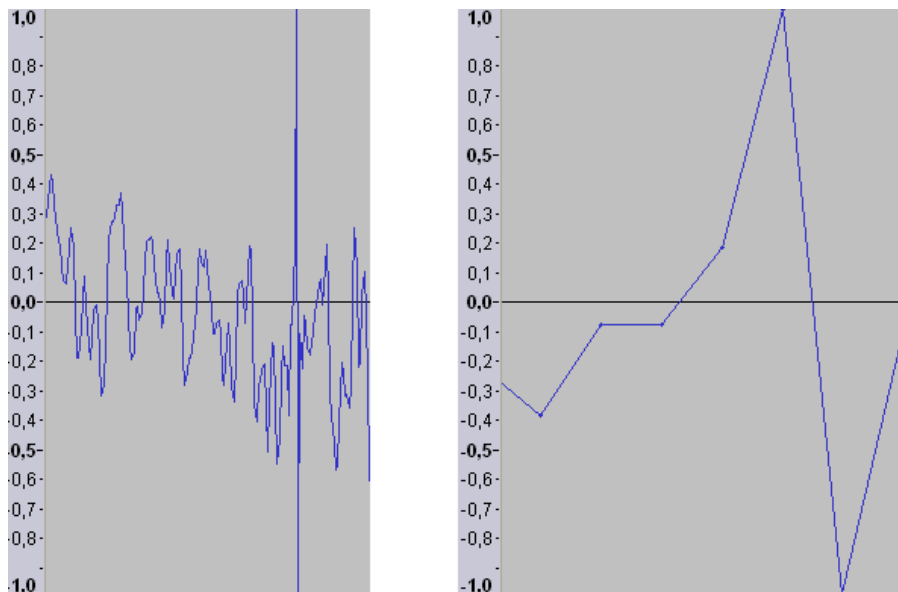

- l. Zoom in on the sound track until you can see the individual samples (points on the line in the picture on the right).
- m. Now you can use the drawing tool to drag the points towards the zero line.

- n. Also, look at the beginning and the end of the loop and use the drawing tool to try to improve the transition. In the picture on the left, the last sample of the loop is in the upper area. If the loop starts again from the beginning, a sample follows directly in the lower area. You should avoid such jumps and design the loop as in the picture on the right.

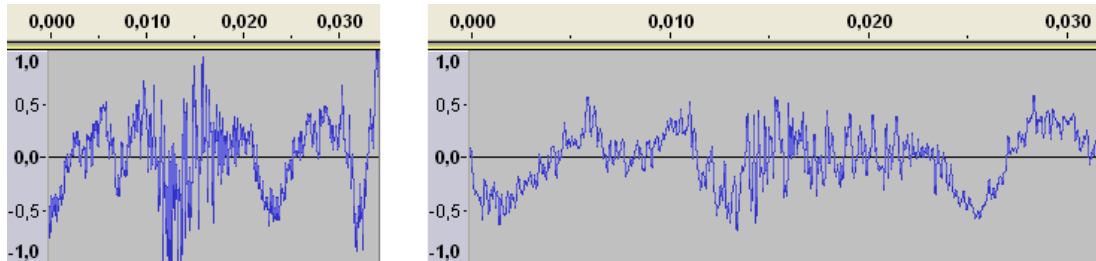

13. Now that you've finished your loop and cue, it's time to play them back and listen to the transition.
14. To do this, open your start-up noise and import your loop by going to "Import" in the "File" menu and clicking on "Audio ...". Now select your loop and click on "Open".
15. You can now see both audio tracks.

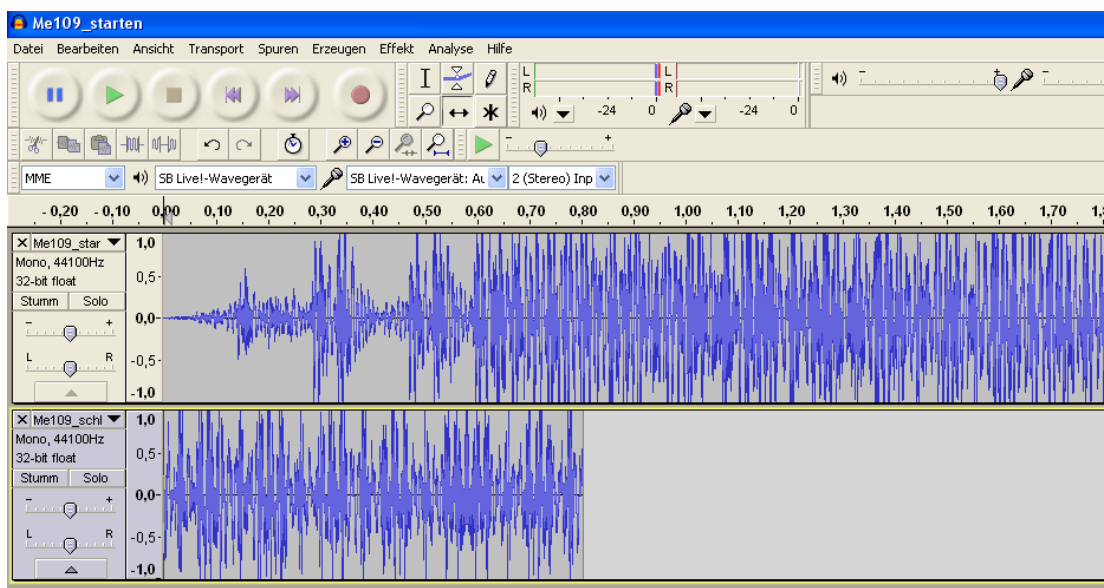

16. Zoom out a little and use the move tool to move the tracks one after the other. The yellow line signals to them that the signals are exactly related to one another.

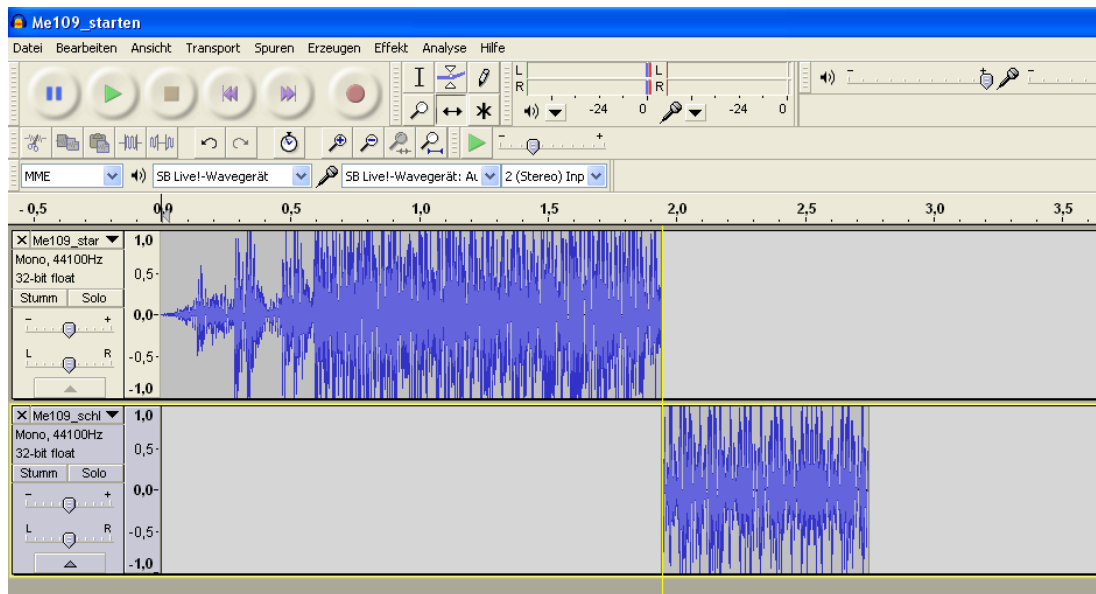

17. With a click on "Fit project."  "You have a better overview.
18. Click with the selection tool at the beginning of the first sound and use the play button to listen to the sound.
19. You can also insert the loop a second time (with "File" and "Import") and append it after the first to listen to the transition.
20. If the transition from starting noise to the loop is bad, there are also ways to improve it:
 - a. Look at the end of the cranking sound and the beginning of the loop. Check whether the signals merge without "jumps" and improve this if necessary (see page 109).
 - b. Open the loop, mark the first 0.2 seconds and click on "Effect" and "Fade in". Remember that the bottom 3 windows can help you with this.
 - c. Leave the selected period highlighted and click on "Copy" in the "Edit" menu.
 - d. Then close the loop without saving!
 - e. Open the start-up sound and go to "Create new track" in the "Tracks" menu and select "Mono track".
 - f. Click with the selection tool in the new track and go to "Edit" on "Paste".
 - g. Now you can use the moving tool to move the inserted part under the last 0.2 seconds of the starting noise.
 - h. With the marking tool you can now mark exactly the same time period in the starting noise.
 - i. In the marked area of the starting noise, you can now use the "fade out" effect.
 - j. Now we import the stationary noise loop, move it to the right place and listen to the overlay.

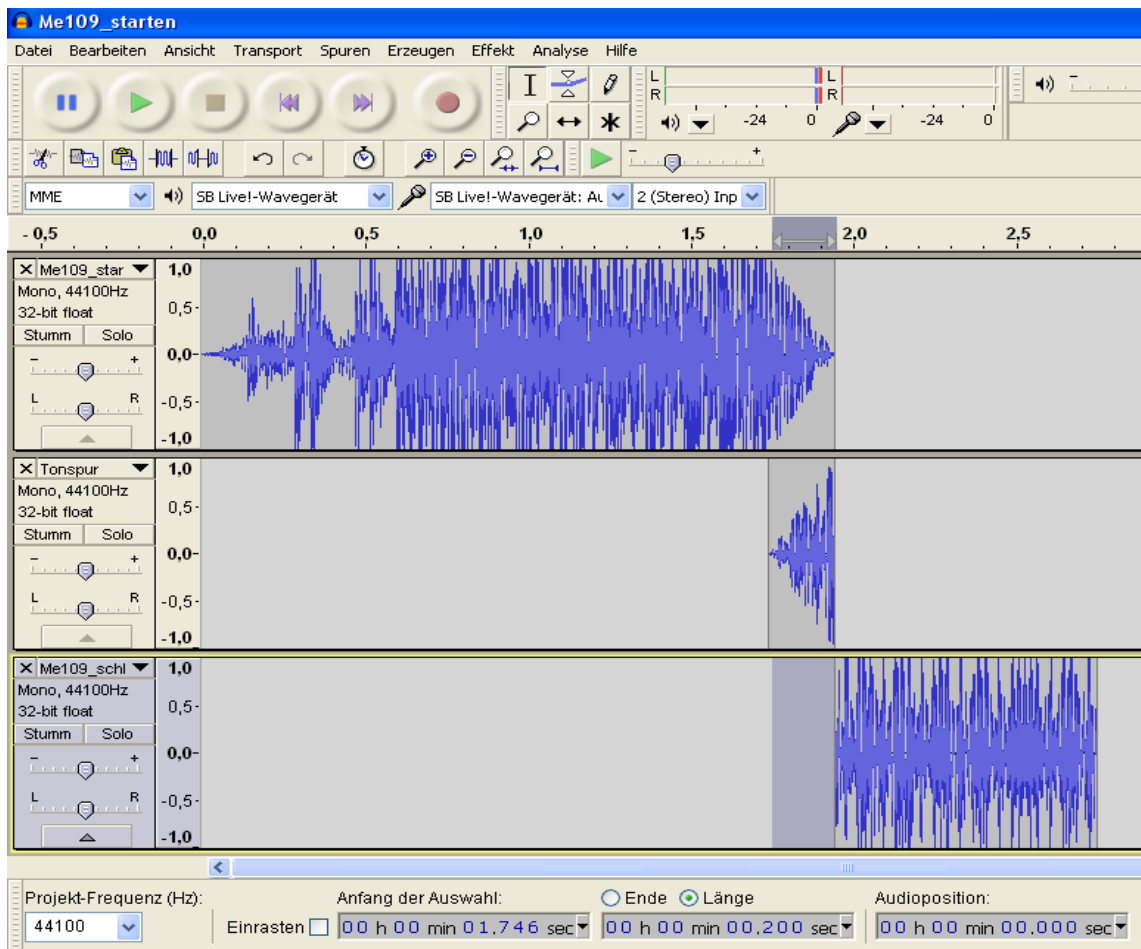

- k. If a slight "cracking" occurs again, it is best to remove this only after the audio tracks have been joined.
 - l. To merge your new cranking noise, first remove the loop and click twice in the "Tracks" menu on "Merge tracks" (so that only one track can be seen).
 - m. Do not forget to save the new start-up sound via "export".
 - n. If you are not satisfied with the result, you can also superimpose a different part of the loop, or you can try to adjust the frequency of the loop and the starting noise a little. To do this, you can try the "Change tempo ..." item under "Effect".
21. Now you still need a suitable stop sound. To do this, go back to the original sound and choose a point from which you want your shutdown sound to begin. When making your selection, make sure that the beginning of the stopping noise is as similar as possible to the loop of the standing noise.
 22. Cut out your selection and save it under a suitable name (eg "abstellgerärm.wav").
 23. Now open your standing noise and import the stop noise.
 24. Slide the shutdown sound behind the standing sound.

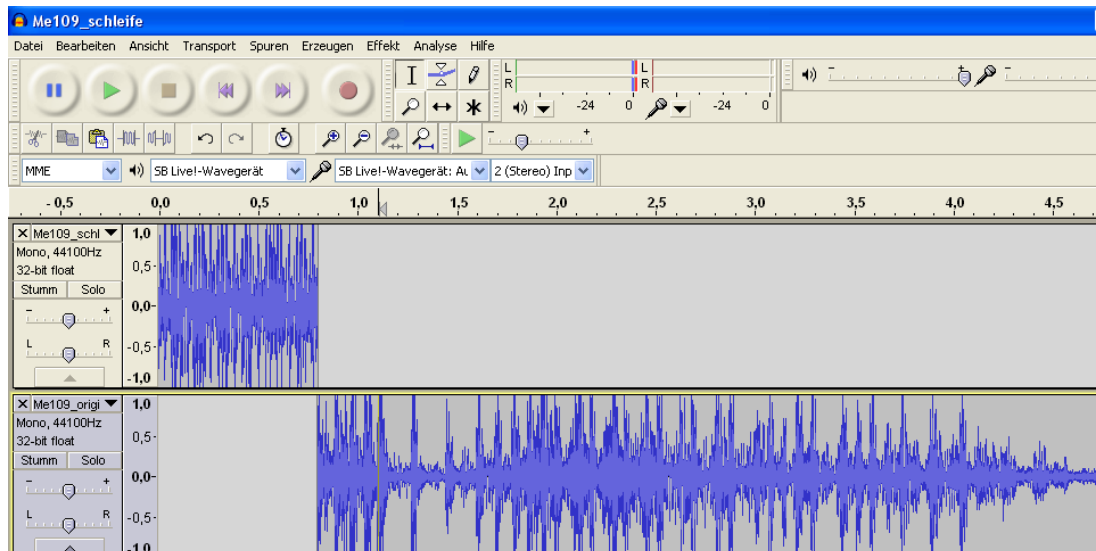

25. First create a "fade out" at the end of the shutdown noise. The length to be selected depends on the sound. In the example, about 0.5s would be optimal.

26. Then listen to the transition from standing noise to stopping noise.

27. If the transition is bad, there are ways to improve it:

- a. Create a "fade out" at the end of the standing noise of, for example, 0.2 seconds, copy this part and undo the "fade out".
- b. Paste the copy into a new mono track.
- c. Now create a "fade in" at the beginning of the shutdown sound that has the same duration as the previously created "fade out".
- d. Now copy the part that is shown and then undo the change.
- e. Paste the copy into a new mono track and arrange the tracks as shown in the picture.

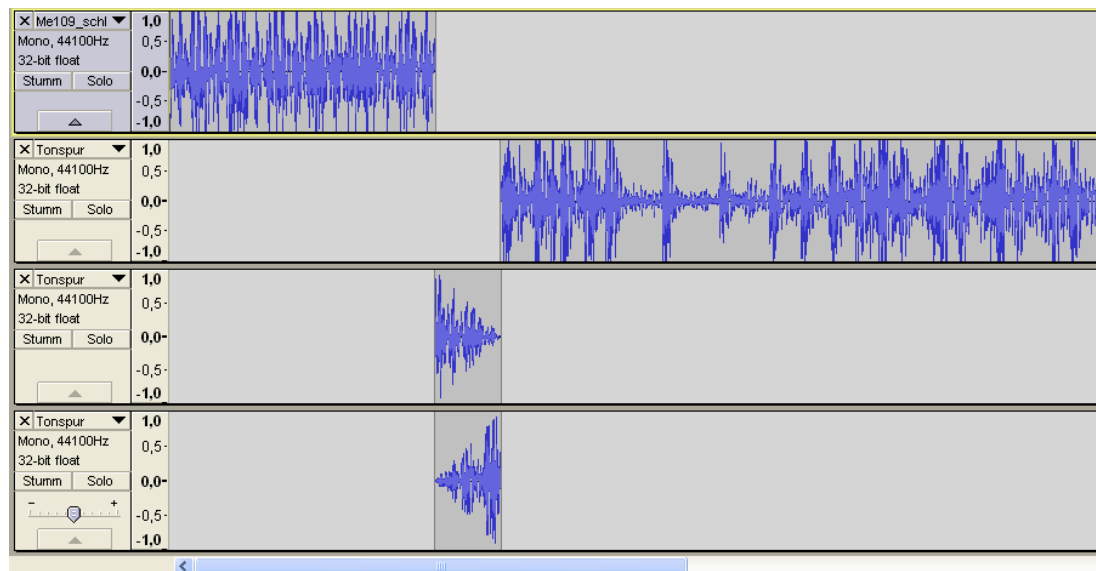

- f. Now listen to the sound
- g. If you are satisfied, you can now put your finished stop sound together. To do this, first remove the standing noise.
- h. Then click twice in the "Tracks" menu on "Merge Tracks"
- i. If you have kept the arrangement as in the last picture, you now only have to delete the silent part at the beginning of the new sound track and your shutdown sound is ready.

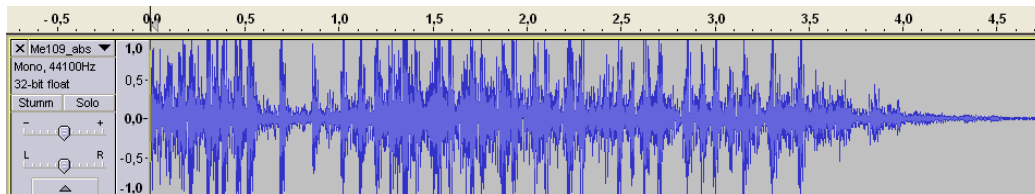

28. Listen to your work by playing the starting noise, the standing noise and the stopping one after the other.

29. If you import the standing noise twice, you can also listen to the loop transition.

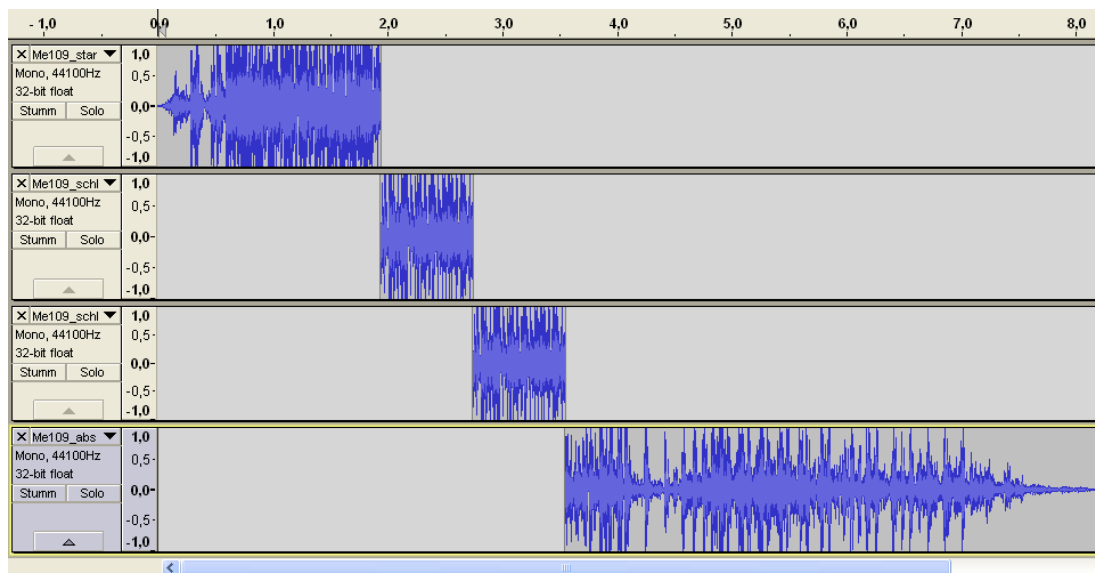

If you are not satisfied, don't give up and try to fix the problem areas. A good sound processing requires a lot of patience and experience. Over time, you will also find that some sounds are harder to edit than others.

Analogous to this description, you can now also try to edit more extensive sounds. It could look like this:

Starting noise → Standing noise (loop) → Start-up noise (transition from the stationary noise loop to the driving noise) → Driving noise (loop) → Stopping noise (transition from the driving noise loop to the stationary noise) → Shutdown noise.

This description can also be used for additional sounds. For example, you can create a machine gun sound consisting of a start sound, a loop and a stop sound.

This concludes the introduction to sound processing with "Audacity".

Of course, the program offers even more options than those explained here.

If you are interested in this, please have a look at the help of the program.

Disposal note:

Discarded electrical and electronic equipment contains a multitude of valuable resources, including precious metals and critical raw materials. Achieving a high collection and recycling rate and the associated return of these raw materials into the production cycle is one of the central goals of the environmentally friendly and sustainable disposal of electrical and electronic equipment.

For this reason, our modules must not be disposed of with normal household waste, but must be collected separately. The communal collection points, such as recycling centers, can be used for this. Larger dealers also offer take-back points that can be used even if the product was not purchased there. We are happy to take over the professional and free disposal. To do this, send the module back to us with sufficient postage (!!!).

Personal data must be deleted independently before disposal.

